

SAMSUNG

GSM TELEPHONE

SGH-E210

SERVICE *Manual*

GSM TELEPHONE



CONTENTS

1. Safety Precautions
2. Specification
3. Product Function
4. Array course control
5. Exploded View and Parts List
6. MAIN Electrical Parts List
7. Block Diagrams
8. PCB Diagrams
9. Flow Chart of Troubleshooting
10. Reference data

**SAMSUNG
ELECTRONICS**



GSPN (Global Service Partner Network)

Country	Web Site
North America	service.samsungportal.com
Latin America	latin.samsungportal.com
CIS	cis.samsungportal.com
Europe	europe.samsungportal.com
China	china.samsungportal.com
Asia	asia.samsungportal.com
Mideast & Africa	mea.samsungportal.com

1. Safety Precautions

1-1. Repair Precaution

- Repair in Shield Box, during detailed tuning.
Take specially care of tuning or test,
because specipcty of cellular phone is sensitive for surrounding interference(RF noise).
- Be careful to use a kind of magnetic object or tool,
because performance of parts is damaged by the influence of manetic force.
- Surely use a standard screwdriver when you disassemble this product,
otherwise screw will be worn away.
- Use a thicken twisted wire when you measure level.
A thicken twisted wire has low resistance, therefore error of measurement is few.
- Repair after separate Test Pack and Set because for short danger (for example an
overcurrent and furious flames of parts etc) when you repair board in condition of
connecting Test Pack and tuning on.
- Take specially care of soldering, because Land of PCB is small and weak in heat.
- Surely tune on/off while using AC power plug, because a repair of battery charger is
dangerous when tuning ON/OFF PBA and Connector after disassembling charger.
- Don't use as you pleases after change other material than replacement registered on SEC
System. Otherwise engineer in charge isn't charged with problem that you don't keep this
rules.

1-2. ESD(Electrostatically Sensitive Devices) Precaution

Several semiconductor may be damaged easily by static electricity. Such parts are called by ESD(Electrostatically Sensitive Devices), for example IC,BGA chip etc. Read Precaution below. You can prevent from ESD damage by static electricity.

- Remove static electricity remained your body before you touch semiconductor or parts with semiconductor. There are ways that you touch an earthed place or wear static electricity prevention string on wrist.
- Use earthed soldering steel when you connect or disconnect ESD.
- Use soldering removing tool to break static electricity. , otherwise ESD will be damaged by static electricity.
- Don't unpack until you set up ESD on product. Because most of ESD are packed by box and aluminum plate to have conductive power,they are prevented from static electricity.
- You must maintain electric contact between ESD and place due to be set up until ESD is connected completely to the proper place or a circuit board.

2. Specification

2-1. GSM General Specification

	GSM 900	DCS1800	PCS1900
Freq. Band[MHz] Uplink/Downlink	880~915 925~960	1710~1785 1805~1880	1850~1910 1930~1990
ARFCN range	0~124 & 975~1023	512~885	512~810
Tx/Rx spacing	45MHz	95MHz	80MHz
Mod. Bit rate/ Bit Period	270.833Kbps 3.692us	270.833Kbps 3.692us	270.833Kbps 3.692us
Time Slot Period /Frame Period	576.9us 4.615ms	576.9us 4.615ms	576.9us 4.615ms
Modulation	0.3GMSK	0.3GMSK	0.3GMSK
MS Power	33dBm~5dBm	30dBm~0dBm	30dBm~0dBm
Power Level	5pcl~19pcl	0pcl~15pcl	0pcl~15pcl
Sensitivity	-102dBm	-100dBm	-102dBm
TDMA Mux	8	8	8
Cell Radius	35Km	2Km	2Km

2-2. GSM Tx Power Class

TX Power control level	GSM900	TX Power control level	DCS1800	TX Power control level	PCS1900
5	33±2dBm	0	30±2dBm	0	30±2dBm
6	31±3dBm	1	28±3dBm	1	28±3dBm
7	29±3dBm	2	26±3dBm	2	26±3dBm
8	27±3dBm	3	24±3dBm	3	24±3dBm
9	25±3dBm	4	22±3dBm	4	22±3dBm
10	23±3dBm	5	20±3dBm	5	20±3dBm
11	21±3dBm	6	18±3dBm	6	18±3dBm
12	19±3dBm	7	16±3dBm	7	16±3dBm
13	17±3dBm	8	14±3dBm	8	14±3dBm
14	15±3dBm	9	12±4dBm	9	12±4dBm
15	13±3dBm	10	10±4dBm	10	10±4dBm
16	11±5dBm	11	8±4dBm	11	8±4dBm
17	9±5dBm	12	6±4dBm	12	6±4dBm
18	7±5dBm	13	4±4dBm	13	4±4dBm
19	5±5dBm	14	2±5dBm	14	2±5dBm
		15	0±5dBm	15	0±5dBm

3. Product Function

Main Function

- Camera and camcorder
- Music player
- FM radio
- Offline mode
- Bluetooth
- Web browser
- Multimedia Message Service(MMS)
- SOS message
- Organiser
-

4. Array course control



Test Jig (GH80-03312A)



Test Cable (GH39-00830A)



RF Test Cable (GH39-00397A)

Software Downloading

4-1. Downloading Binary Files

- Three binary files for downloading SGH-E210.
 - E210XXYY.s3 : Main source code binary.

4-2. Pre-requisite for Downloading

- Downloader Program([OptiFlash.exe](#))
- E210 Mobile Phone
- Data Cable
- Binary files

4-3. S/W Downloader Program

1. Load the binary download program by executing the **"OptiFlash.exe"**

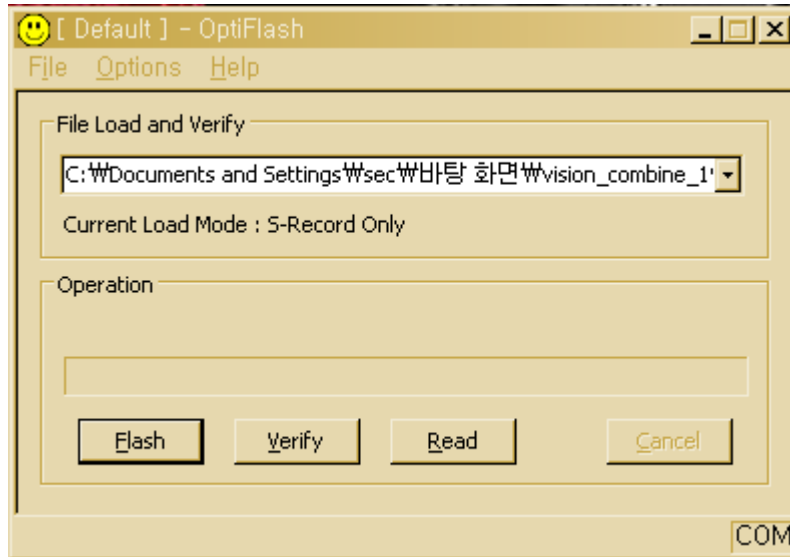

2. Select the **"Options" -> "Settings" -> "Generic" -> "Specify hardware platform"**.

Choose hardware platform for the downloader file setting.

Set the everything else as the default values which are shown below

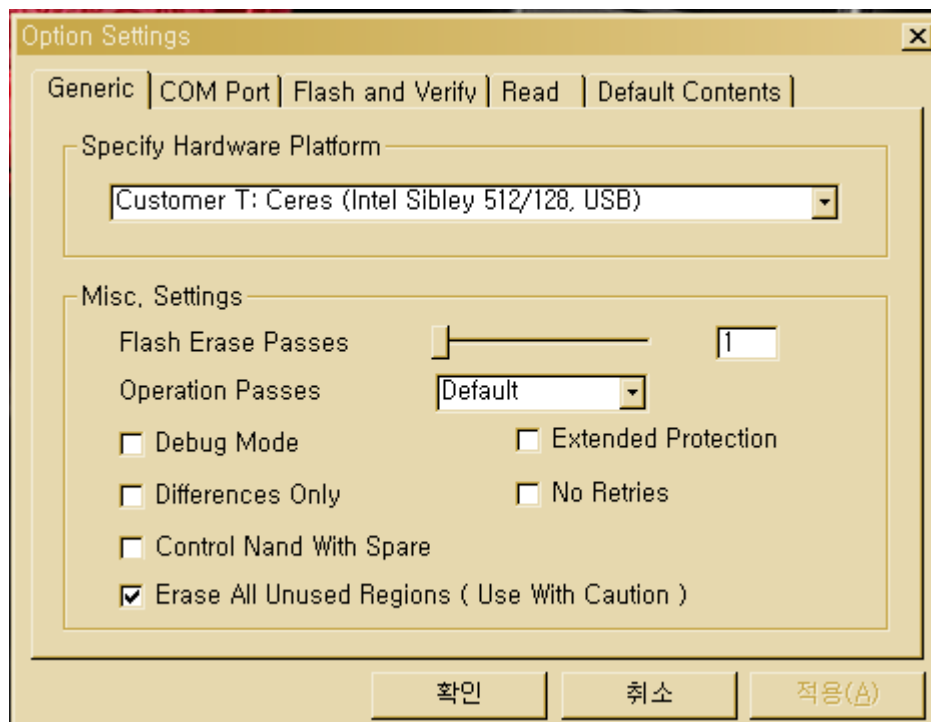

3. Select the **COM port** when the download cable is connected

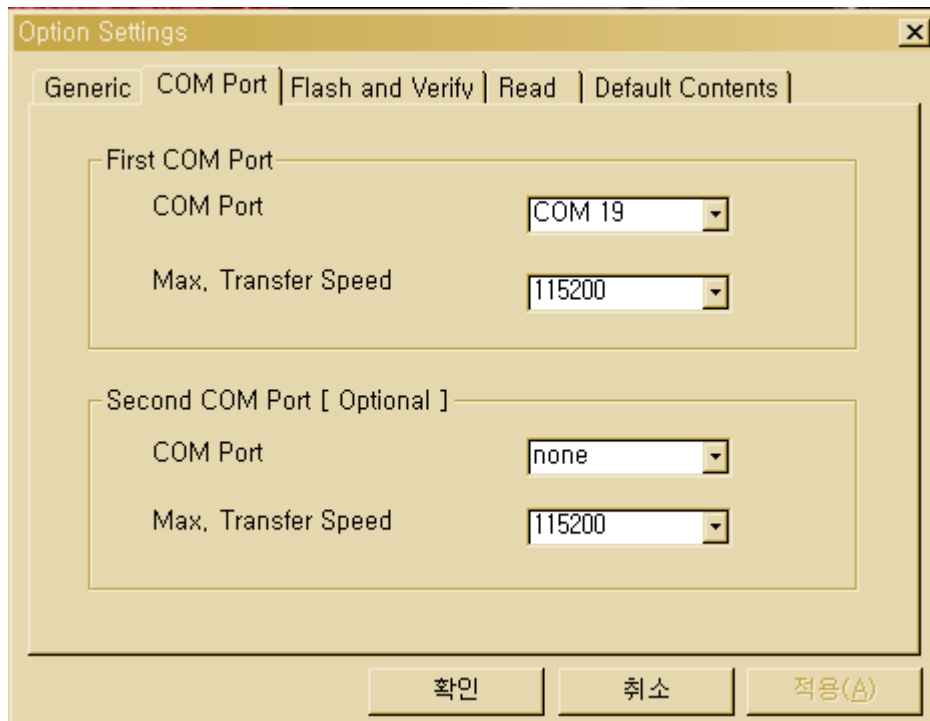

Up to 64 ports are supported. Additionally you can select the maximum transfer speed OptiFlash will use to communicate with the phone. However, OptiFlash will use a slower speed if either the PC's or the phone's serial hardware is incapable of handling the selected speed

4. Select the "Flash&Verify" -> "Browse"

Set the directory path and choose the latest s/w binary, for example "E210XXYY.s3", for the downloader binary setting.

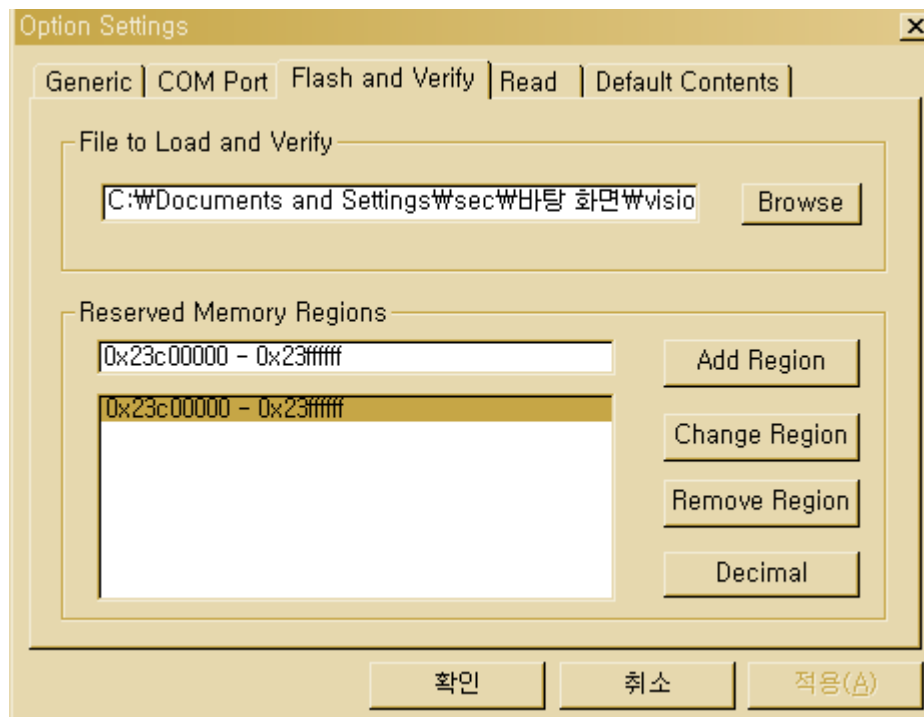

Make sure that not to change the reserved memory regions.

**In case of E210 the reserved memory regions are :
-0x23c00000 ~ 0x23ffff**

5. Click "OK" button then press "Flash".
(Before pressing 'Flash' button, push the button '*'and 'END' at the same time. Then press 'Flash'.)

Downloader will upload the binary file as below for the downloading.

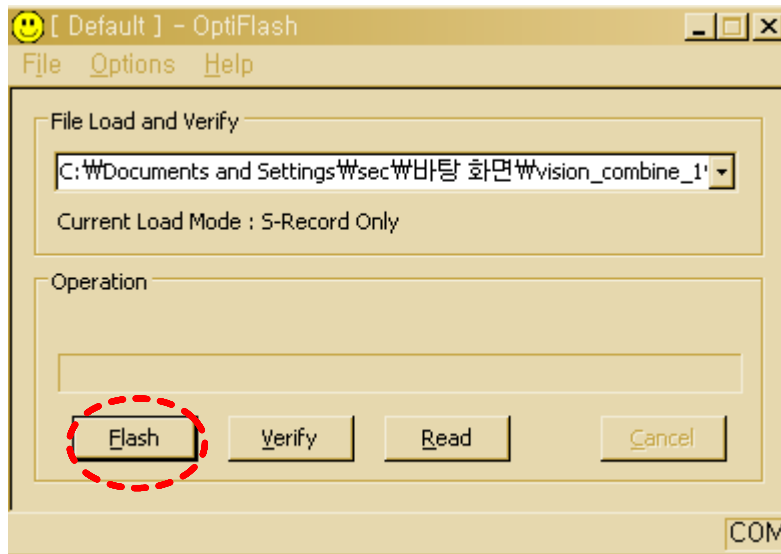

6. When downloading is finished successfully, there is a "All is well" message.
7. After finishing downloading, Certain memory resets should be done to guarantee the normal performance.
8. Confirm the downloaded version name and etc. :

***#1234#**

Full Reset :

***2767*3855#**

5. Exploded View and Parts List

5-1. Cellular phone Exploded View

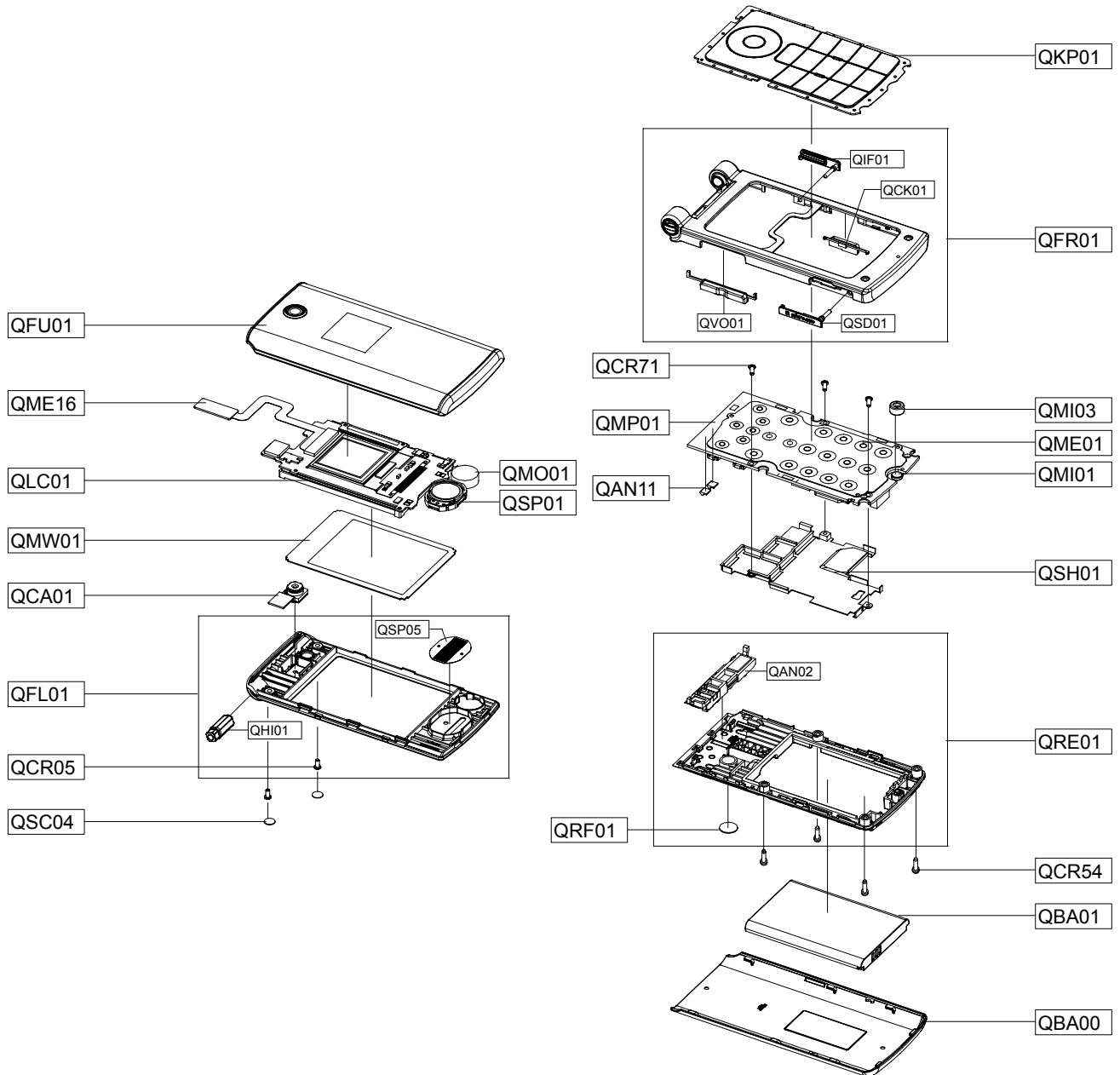

5-2. Cellular phone Parts list

Design LOC	Discription	SEC CODE	
QAN11	ASSY-CUSHION-CUSHION RUBBER IN	GH98-01077A	
QBA00	ASSY COVER-BATT	GH98-05107A	
QBA01	INNER BATTERY PACK-800MAH,MAIN	GH43-02589A	
QCA01	CAMERA MODULE-SGHE210	GH59-04657A	
QCR05	SCREW-MACHINE	6001-001478	
QCR54	SCREW-MACHINE	6001-001645	
QCR71	SCREW-MACHINE	6001-002095	
QFU01	ASSY CASE-FOLDER UPPER	GH98-03571A	
QKP01	ASSY KEYPAD-MAIN(XEN/ZK)	GH98-05104A	
QME01	DOME SHEET-SGHE210 TF DOME SHE	GH59-04560A	
QME16	ASSY ETC-SGHE210 CON TO CON	GH59-04024A	
QMI01	MICROPHONE-ASSY-SGHE210	GH30-00408A	
QMI03	RMO-MIC HOLDER	GH73-05342A	
QMO01	MOTOR BLOWER-SCHA530 MOTOR	GH31-00047A	
QMP01	PBA MAIN-SGHE210	GH92-03388A	
QMW01	ASSY COVER-MAIN WINDOW	GH98-05105A	
QSC04	TAPE-SCREW SHEET	GH74-32473A	
QSH01	IPR COVER-SHIELD	GH70-02471A	
QSP01	SPEAKER	3001-002188	
QRF01	TAPE-RF SHEET	GH74-32474A	
QLC01	ELA UNIT-SGHE210 LCD MODULE SV	GH96-02766A	
QFL01	ASSY CASE-FOLDER LOWER	GH98-03572A	
	QHI01	ASSY MEC-HINGE	GH75-09605A
	QSP05	ASSY DECO-SPK IN	GH98-05106A
QRE01	ASSY CASE-REAR	GH98-03574A	
	QAN02	INTENNA-SGHE210	GH42-01145A
QFR01	ASSY CASE-FRONT	GH98-03573A	
	QCK01	PMO KEY-CAMERA	GH72-42023A
	QIF01	PMO COVER-IF	GH72-42196A
	QSD01	PMO COVER-MICRO SD	GH72-42157A
	QVO01	PMO KEY-VOLUME	GH72-42160A

Discription	SEC CODE
BAG PE	6902-000297
ADAPTOR-ATADS10EBE,BLK,EU	GH44-01702A
EARPHONE-SGHE210,HEADSET,BLK,A	GH59-04535A
LABEL(P)-UNIT SEAL	GH68-00518B
LABEL(R)-WATER SOAK	GH68-09361A
MANUAL USERS-EU ENGLISH	GH68-13874A
MANUAL USERS-EU PORTUGUESE	GH68-13884A
LABEL(R)-MAIN(EU)	GH68-13957A
BOX(P)-UNIT MAIN(EU)	GH69-05052A
CUSHION-CASE TA2 MA2	GH69-05053A
MPR-REMOVE TAPE LCD	GH74-13804A
TAPE GASK	GH74-31842A
TAPE INSU	GH74-32033A
TAPE	GH74-33512A
TAPE-LOWER	GH74-33601A
TAPE	GH74-33602A
TAPE	GH74-33809A
TAPE GASK	GH74-33810A
SPONGE-SOUND LCD	GH74-33913A
VINYL-BOHO UPPER 2	GH74-34251A

6. MAIN Electrical Parts List

SEC CODE	Design LOC	Discription	STATUS
GH71-06262A	ANT100	NPR-ANTENNA CONTACT V2	SA
GH71-06262A	ANT101	NPR-ANTENNA CONTACT V2	SA
GH13-00044A	UCD301	IC ASIC-SGHE490	SA
4709-001422	MOD101	BLUETOOTH MODULE	SA
4302-001130	BAT300	BATTERY-LI(2ND)	SA
4202-001325	ANT102	ANTENNA-CHIP	SA
3711-006228	BTC400	HEADER-BATTERY	SA
3711-006015	HEA400	HEADER-BOARD TO BOARD	SA
3710-002499	IFC400	SOCKET-INTERFACE	SA
3709-001392	CN201	CONNECTOR-CARD EDGE	SA
3709-001384	SIM200	CONNECTOR-CARD EDGE	SA
3705-001358	RFS100	CONNECTOR-COAXIAL	SA
3404-001152	TAC400	SWITCH-TACT	SA
3404-001152	TAC401	SWITCH-TACT	SA
3404-001152	TAC402	SWITCH-TACT	SA
3301-001912	L109	BEAD-SMD	SA
3301-001120	L400	BEAD-SMD	SA
3301-001120	L401	BEAD-SMD	SA
2904-001600	F103	FILTER-SAW	SA
2904-001599	F102	FILTER-SAW	SA
2904-001592	F101	FILTER-SAW	SA
2801-004466	OSC301	CRYSTAL-SMD	SA
2801-004455	OSC100	CRYSTAL-SMD	SA
2801-004340	OSC300	CRYSTAL-SMD	SA
2703-003196	L500	INDUCTOR-SMD	SA
2703-002910	L101	INDUCTOR-SMD	SA
2703-002906	L102	INDUCTOR-SMD	SA
2703-002906	L104	INDUCTOR-SMD	SA
2703-002900	L106	INDUCTOR-SMD	SA
2703-002782	L300	INDUCTOR-SMD	SA
2703-002603	L103	INDUCTOR-SMD	SA
2703-002603	L105	INDUCTOR-SMD	SA
2703-002485	L100	INDUCTOR-SMD	SA
2703-002208	L108	INDUCTOR-SMD	SA
2703-002207	L107	INDUCTOR-SMD	SA
2404-001484	TA401	C-TA,CHIP	SA
2404-001484	TA402	C-TA,CHIP	SA

SEC CODE	Design LOC	Discription	STATUS
2404-001414	TA403	C-TA,CHIP	SA
2404-001414	TA404	C-TA,CHIP	SA
2404-001406	TA400	C-TA,CHIP	SA
2404-001381	TA405	C-TA,CHIP	SA
2404-001381	TA406	C-TA,CHIP	SA
2203-006979	C235	C-CER,CHIP	SA
2203-006838	C126	C-CER,CHIP	SA
2203-006838	C127	C-CER,CHIP	SA
2203-006838	C215	C-CER,CHIP	SA
2203-006838	C314	C-CER,CHIP	SA
2203-006838	C349	C-CER,CHIP	SA
2203-006838	C350	C-CER,CHIP	SA
2203-006838	C351	C-CER,CHIP	SA
2203-006648	C116	C-CER,CHIP	SA
2203-006648	C466	C-CER,CHIP	SA
2203-006648	C467	C-CER,CHIP	SA
2203-006585	C400	C-CER,CHIP	SA
2203-006585	C401	C-CER,CHIP	SA
2203-006562	C128	C-CER,CHIP	SA
2203-006562	C132	C-CER,CHIP	SA
2203-006562	C134	C-CER,CHIP	SA
2203-006562	C135	C-CER,CHIP	SA
2203-006562	C223	C-CER,CHIP	SA
2203-006562	C313	C-CER,CHIP	SA
2203-006562	C317	C-CER,CHIP	SA
2203-006562	C328	C-CER,CHIP	SA
2203-006562	C331	C-CER,CHIP	SA
2203-006562	C340	C-CER,CHIP	SA
2203-006562	C341	C-CER,CHIP	SA
2203-006562	C342	C-CER,CHIP	SA
2203-006562	C343	C-CER,CHIP	SA
2203-006562	C344	C-CER,CHIP	SA
2203-006562	C345	C-CER,CHIP	SA
2203-006562	C346	C-CER,CHIP	SA
2203-006562	C347	C-CER,CHIP	SA
2203-006562	C348	C-CER,CHIP	SA
2203-006562	C368	C-CER,CHIP	SA

SEC CODE	Design LOC	Discription	STATUS
2203-006562	C370	C-CER,CHIP	SA
2203-006562	C372	C-CER,CHIP	SA
2203-006562	C404	C-CER,CHIP	SA
2203-006562	C405	C-CER,CHIP	SA
2203-006562	C406	C-CER,CHIP	SA
2203-006562	C450	C-CER,CHIP	SA
2203-006562	C460	C-CER,CHIP	SA
2203-006562	C473	C-CER,CHIP	SA
2203-006556	C104	C-CER,CHIP	SA
2203-006556	C200	C-CER,CHIP	SA
2203-006474	C316	C-CER,CHIP	SA
2203-006423	C113	C-CER,CHIP	SA
2203-006423	C117	C-CER,CHIP	SA
2203-006423	C118	C-CER,CHIP	SA
2203-006423	C119	C-CER,CHIP	SA
2203-006423	C129	C-CER,CHIP	SA
2203-006423	C202	C-CER,CHIP	SA
2203-006423	C204	C-CER,CHIP	SA
2203-006423	C206	C-CER,CHIP	SA
2203-006423	C207	C-CER,CHIP	SA
2203-006423	C208	C-CER,CHIP	SA
2203-006423	C211	C-CER,CHIP	SA
2203-006423	C212	C-CER,CHIP	SA
2203-006423	C233	C-CER,CHIP	SA
2203-006423	C300	C-CER,CHIP	SA
2203-006423	C301	C-CER,CHIP	SA
2203-006423	C302	C-CER,CHIP	SA
2203-006423	C303	C-CER,CHIP	SA
2203-006423	C338	C-CER,CHIP	SA
2203-006423	C367	C-CER,CHIP	SA
2203-006423	C373	C-CER,CHIP	SA
2203-006361	C122	C-CER,CHIP	SA
2203-006361	C334	C-CER,CHIP	SA
2203-006361	C339	C-CER,CHIP	SA
2203-006318	C105	C-CER,CHIP	SA
2203-006318	C108	C-CER,CHIP	SA
2203-006318	C109	C-CER,CHIP	SA

SEC CODE	Design LOC	Discription	STATUS
2203-006318	C110	C-CER,CHIP	SA
2203-006318	C112	C-CER,CHIP	SA
2203-006260	C130	C-CER,CHIP	SA
2203-006257	C318	C-CER,CHIP	SA
2203-006194	C114	C-CER,CHIP	SA
2203-006194	C115	C-CER,CHIP	SA
2203-006194	C209	C-CER,CHIP	SA
2203-006194	C234	C-CER,CHIP	SA
2203-006194	C319	C-CER,CHIP	SA
2203-006194	C320	C-CER,CHIP	SA
2203-006194	C321	C-CER,CHIP	SA
2203-006194	C374	C-CER,CHIP	SA
2203-006183	C220	C-CER,CHIP	SA
2203-006048	C305	C-CER,CHIP	SA
2203-005792	C100	C-CER,CHIP	SA
2203-005792	C103	C-CER,CHIP	SA
2203-005736	C101	C-CER,CHIP	SA
2203-005736	C106	C-CER,CHIP	SA
2203-005736	C111	C-CER,CHIP	SA
2203-005736	C123	C-CER,CHIP	SA
2203-005736	C222	C-CER,CHIP	SA
2203-005731	C102	C-CER,CHIP	SA
2203-005725	C441	C-CER,CHIP	SA
2203-005725	C442	C-CER,CHIP	SA
2203-005725	C443	C-CER,CHIP	SA
2203-005683	C438	C-CER,CHIP	SA
2203-005683	C439	C-CER,CHIP	SA
2203-005683	C440	C-CER,CHIP	SA
2203-005683	C448	C-CER,CHIP	SA
2203-005682	C107	C-CER,CHIP	SA
2203-005682	C120	C-CER,CHIP	SA
2203-005682	C121	C-CER,CHIP	SA
2203-005682	C124	C-CER,CHIP	SA
2203-005682	C125	C-CER,CHIP	SA
2203-005682	C407	C-CER,CHIP	SA
2203-005682	C408	C-CER,CHIP	SA
2203-005682	C409	C-CER,CHIP	SA

SEC CODE	Design LOC	Discription	STATUS
2203-005682	C410	C-CER,CHIP	SA
2203-005682	C411	C-CER,CHIP	SA
2203-005682	C412	C-CER,CHIP	SA
2203-005682	C413	C-CER,CHIP	SA
2203-005682	C414	C-CER,CHIP	SA
2203-005682	C415	C-CER,CHIP	SA
2203-005682	C416	C-CER,CHIP	SA
2203-005682	C417	C-CER,CHIP	SA
2203-005682	C418	C-CER,CHIP	SA
2203-005682	C419	C-CER,CHIP	SA
2203-005682	C420	C-CER,CHIP	SA
2203-005682	C421	C-CER,CHIP	SA
2203-005682	C422	C-CER,CHIP	SA
2203-005682	C423	C-CER,CHIP	SA
2203-005682	C424	C-CER,CHIP	SA
2203-005682	C425	C-CER,CHIP	SA
2203-005682	C426	C-CER,CHIP	SA
2203-005682	C427	C-CER,CHIP	SA
2203-005682	C430	C-CER,CHIP	SA
2203-005682	C431	C-CER,CHIP	SA
2203-005682	C432	C-CER,CHIP	SA
2203-005682	C433	C-CER,CHIP	SA
2203-005682	C434	C-CER,CHIP	SA
2203-005682	C435	C-CER,CHIP	SA
2203-005682	C436	C-CER,CHIP	SA
2203-005682	C437	C-CER,CHIP	SA
2203-005682	C444	C-CER,CHIP	SA
2203-005682	C445	C-CER,CHIP	SA
2203-005552	C131	C-CER,CHIP	SA
2203-005483	C454	C-CER,CHIP	SA
2203-005483	C462	C-CER,CHIP	SA
2203-005483	C464	C-CER,CHIP	SA
2203-005483	C474	C-CER,CHIP	SA
2203-005482	C136	C-CER,CHIP	SA
2203-005482	C137	C-CER,CHIP	SA
2203-005482	C224	C-CER,CHIP	SA
2203-005482	C225	C-CER,CHIP	SA

SEC CODE	Design LOC	Discription	STATUS
2203-005482	C228	C-CER,CHIP	SA
2203-005482	C371	C-CER,CHIP	SA
2203-005482	C476	C-CER,CHIP	SA
2203-005050	C140	C-CER,CHIP	SA
2203-002709	C214	C-CER,CHIP	SA
2203-002709	C221	C-CER,CHIP	SA
2203-002709	C232	C-CER,CHIP	SA
2203-002709	C315	C-CER,CHIP	SA
2203-002709	C472	C-CER,CHIP	SA
2203-001072	C310	C-CER,CHIP	SA
2203-001072	C311	C-CER,CHIP	SA
2203-000940	C227	C-CER,CHIP	SA
2203-000812	C226	C-CER,CHIP	SA
2203-000812	C229	C-CER,CHIP	SA
2203-000812	C230	C-CER,CHIP	SA
2203-000812	C428	C-CER,CHIP	SA
2203-000812	C429	C-CER,CHIP	SA
2203-000550	C357	C-CER,CHIP	SA
2203-000550	C358	C-CER,CHIP	SA
2203-000438	C402	C-CER,CHIP	SA
2203-000438	C403	C-CER,CHIP	SA
2203-000330	C329	C-CER,CHIP	SA
2203-000330	C330	C-CER,CHIP	SA
2203-000311	C456	C-CER,CHIP	SA
2203-000311	C457	C-CER,CHIP	SA
2203-000311	C459	C-CER,CHIP	SA
2203-000254	C213	C-CER,CHIP	SA
2203-000254	C216	C-CER,CHIP	SA
2203-000254	C337	C-CER,CHIP	SA
2203-000233	C133	C-CER,CHIP	SA
2203-000233	C231	C-CER,CHIP	SA
2203-000189	C471	C-CER,CHIP	SA
2007-009115	R315	R-CHIP	SA
2007-009084	R318	R-CHIP	SA
2007-008816	R227	R-CHIP	SA
2007-008816	R228	R-CHIP	SA
2007-008809	R308	R-CHIP	SNA

SEC CODE	Design LOC	Discription	STATUS
2007-008774	R259	R-CHIP	SA
2007-008579	R257	R-CHIP	SA
2007-008531	R266	R-CHIP	SA
2007-008531	R319	R-CHIP	SA
2007-008516	R243	R-CHIP	SA
2007-008483	R102	R-CHIP	SA
2007-008483	R105	R-CHIP	SA
2007-008483	R412	R-CHIP	SA
2007-008478	R248	R-CHIP	SA
2007-008420	R250	R-CHIP	SA
2007-008420	R252	R-CHIP	SA
2007-008419	R414	R-CHIP	SA
2007-008419	R416	R-CHIP	SA
2007-008419	R417	R-CHIP	SA
2007-008419	R418	R-CHIP	SA
2007-008055	R103	R-CHIP	SA
2007-008055	R104	R-CHIP	SA
2007-008055	R320	R-CHIP	SA
2007-008045	R425	R-CHIP	SA
2007-007741	R100	R-CHIP	SA
2007-007741	R101	R-CHIP	SA
2007-007314	R305	R-CHIP	SA
2007-007308	R304	R-CHIP	SA
2007-007190	R404	R-CHIP	SA
2007-007190	R405	R-CHIP	SA
2007-002965	R407	R-CHIP	SA
2007-002965	R409	R-CHIP	SA
2007-002965	R429	R-CHIP	SA
2007-002965	R430	R-CHIP	SA
2007-001288	R426	R-CHIP	SA
2007-001288	R427	R-CHIP	SA
2007-001288	R428	R-CHIP	SA
2007-000775	R400	R-CHIP	SA
2007-000775	R401	R-CHIP	SA
2007-000242	R410	R-CHIP	SA
2007-000242	R415	R-CHIP	SA
2007-000242	R419	R-CHIP	SA

SEC CODE	Design LOC	Discription	STATUS
2007-000242	R422	R-CHIP	SA
2007-000173	R406	R-CHIP	SA
2007-000173	R408	R-CHIP	SA
2007-000170	R261	R-CHIP	SA
2007-000170	R402	R-CHIP	SA
2007-000170	R403	R-CHIP	SA
2007-000168	R246	R-CHIP	SA
2007-000162	R256	R-CHIP	SA
2007-000157	R247	R-CHIP	SA
2007-000153	R413	R-CHIP	SA
2007-000153	R421	R-CHIP	SA
2007-000148	R267	R-CHIP	SA
2007-000138	R411	R-CHIP	SA
2007-000138	R420	R-CHIP	SA
1405-001082	V200	VARISTOR	SA
1405-001082	VR400	VARISTOR	SA
1405-001082	VR401	VARISTOR	SA
1405-001082	VR403	VARISTOR	SA
1405-001082	VR404	VARISTOR	SA
1405-001082	VR405	VARISTOR	SA
1404-001165	TH300	THERMISTOR-NTC	SA
1205-003224	UCP200	IC-DATA COMM./GEN.	SA
1205-003116	UCD101	IC-TRANSCEIVER	SA
1205-002272	U204	IC-TRANSCEIVER	SA
1204-002746	U100	IC-TUNER	SA
1203-004763	U205	IC-VOL. DETECTOR	SA
1203-004663	UCD300	IC-POWER SUPERVISOR	SA
1201-002304	U407	IC-AUDIO AMP	SA
1201-002278	PAM100	IC-POWER AMP	SA
1108-000046	UME200	IC-MCP	SA
1009-001035	U202	IC-HALL EFFECT S/W	SA
1001-001405	U400	IC-ANALOG MULTIPLEX	SA
1001-001405	U408	IC-ANALOG MULTIPLEX	SA
0601-002268	LED400	LED	SA
0601-002268	LED401	LED	SA
0601-002268	LED402	LED	SA
0406-001254	ZD404	DIODE-TVS	SA

SEC CODE	Design LOC	Discription	STATUS
0406-001254	ZD405	DIODE-TVS	SA
0406-001241	U401	DIODE-TVS	SA
0406-001241	U402	DIODE-TVS	SA
0406-001241	U403	DIODE-TVS	SA
0406-001241	U404	DIODE-TVS	SA
0406-001241	U405	DIODE-TVS	SA
0406-001241	U406	DIODE-TVS	SA
0406-001237	U201	DIODE-TVS	SNA
0403-001547	ZD402	DIODE-ZENER	SA
0403-001547	ZD403	DIODE-ZENER	SA
0403-001427	ZD406	DIODE-ZENER	SA

7. Disassembly and Assembly Instructions

7-1. Disassembly

1



※ **caution**

1) Remove battery and SIM card.

2



1) Unscrew 4 screws.

※ **caution**

1) Be careful not to scratch molding.

3

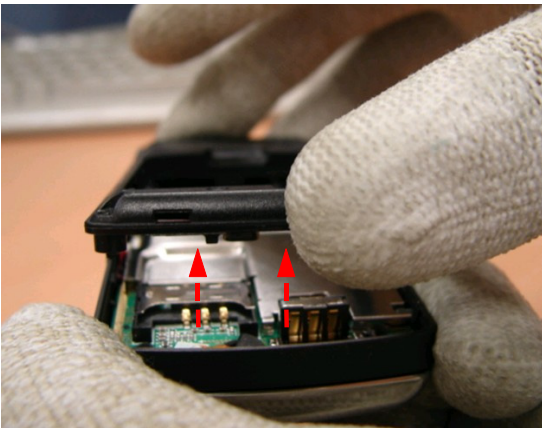

1) Lift up the REAR CASE and separate it from the FRONT.

※ **caution**

1) Be careful not to damage LOCKER.

4

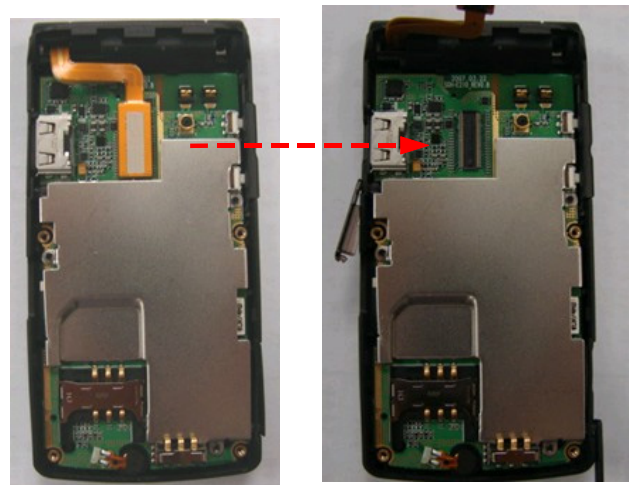

1) Separate LCD CONNECTOR from the PBA using tweezers.

※ **caution**

1) Be careful not to damage the components around LCD CONNECTOR.

5

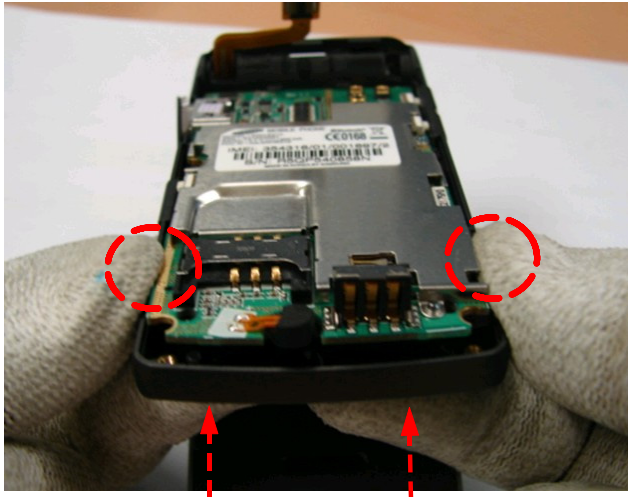

- 1) Lift up the PBA by pushing the keypad.
- ※ **caution**
- 1) Be careful not to damage the FRONT molding.

6

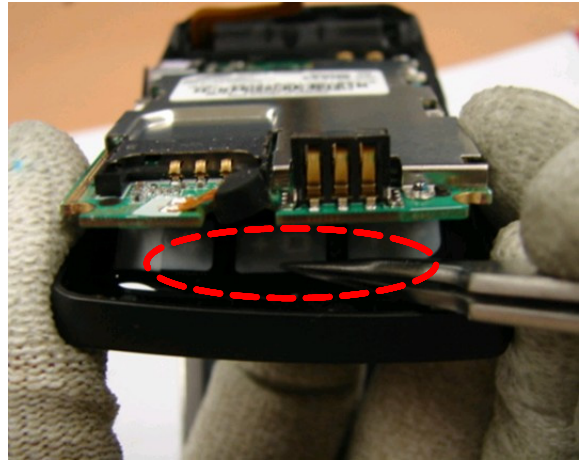

- 1) Slowly separate the PBA from the keypad using tweezers.
- ※ **caution**
- 1) Be careful not to damage double-faced tape on the keypad.
 - 2) Be careful not to damage the DOPARO SHEET (light guide film) .

7



- 1) Remove the keypad from the ass'y.
- ※ **caution**
- 1) Be careful not to damage double-faced tape on the keypad.

8

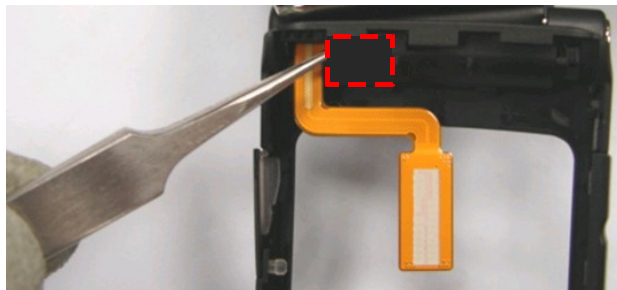

- 1) Remove the black tape with tweezers.
- ※ **caution**
- 1) Be careful not to damage the LCD FPCB.

9



1) Push the Hinge with tweezers(Top view) and separate the FOLDER Ass'y from the FRONT.

※ **caution**

1) Be careful not to damage the FRONT molding and the Hinge.

10



1) Separate the FOLDER Ass'y from the FRONT.

※ **caution**

1) Be careful not to damage the LCD FPCB.

11



1) Remove the two screw sheets.

※ **caution**

1) Be careful not to scratch molding.

12

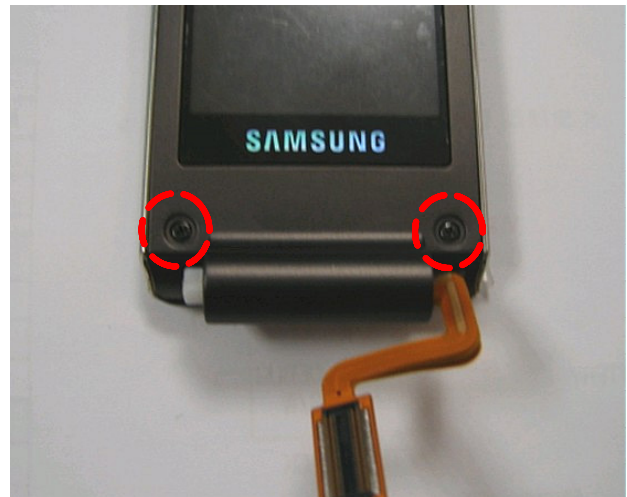

1) Unscrew at two points.

※ **caution**

1) Be careful not to scratch molding.

13

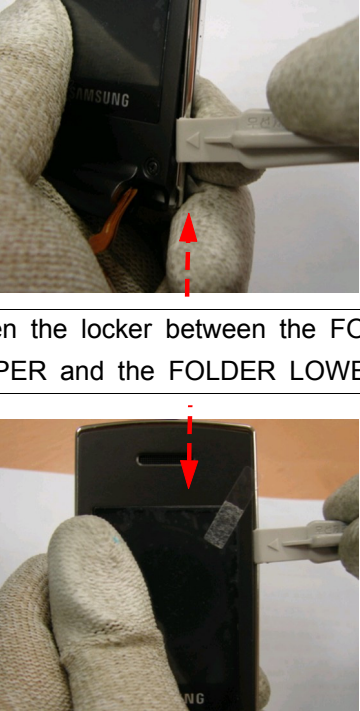

1) Open the locker between the FOLDED UPPER and the FOLDER LOWER.

*** caution**
1) Be careful not to scratch molding.

15

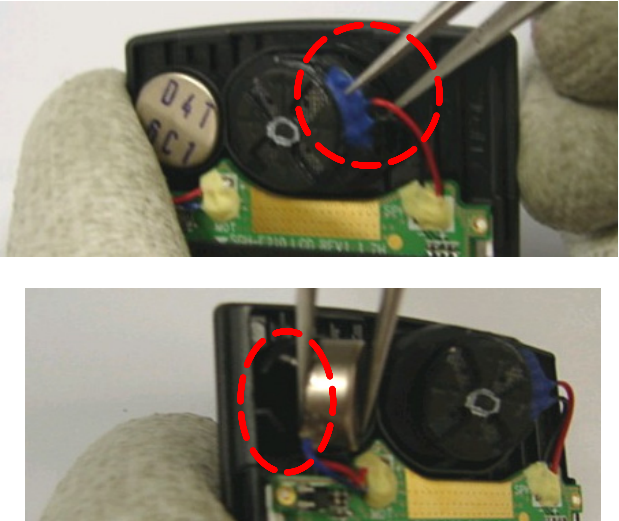

1) Using tweezers, separate the SPEAKER from the FOLDER LOWER.
2) Do for the MOTOR in the same way.

*** caution**
1) Be careful not to damage the PEAKER/MOTOR and wires.

14



1) Separate the UPPER and the LOWER.
*** caution**
1) Be careful not to damage LOCKER and molding

16

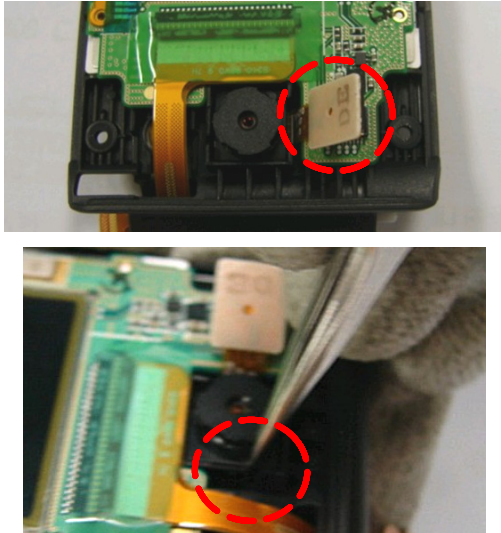

1) Open the camera connector with tweezers.
1) Separate the CAMERA from the FOLDER LOWER using tweezers.
*** caution**
1) Be careful not to damage components around the connector.
2) Be careful not to damage the CAMERA MODULE.

17



1) Bend the LOWER slightly and separate the LCD and the LOWER.

※ **caution**

1) Do not touch LCD GLASS with your hands.

18



1) Separate the LCD FPCB from the LOWER.

※ **caution**

1) Be careful not to damage the LCD FPCB.

19



1) Completed.

※ **caution**

1) Be careful not to leave any foreign substance or fingerprint on the SUB-LCD.

7-2. Assembly

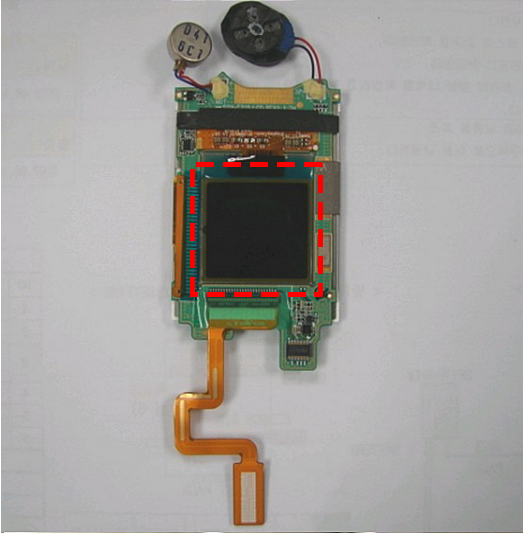
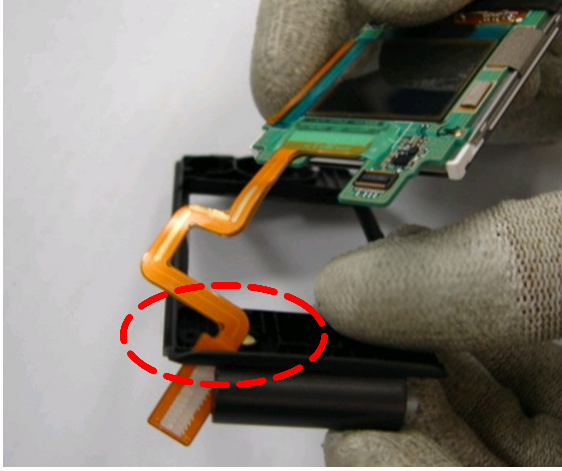
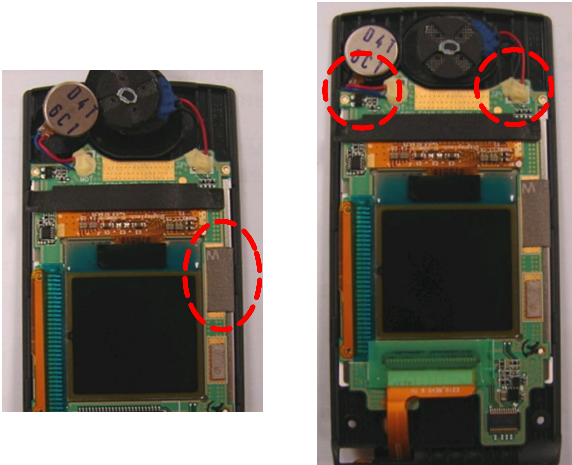
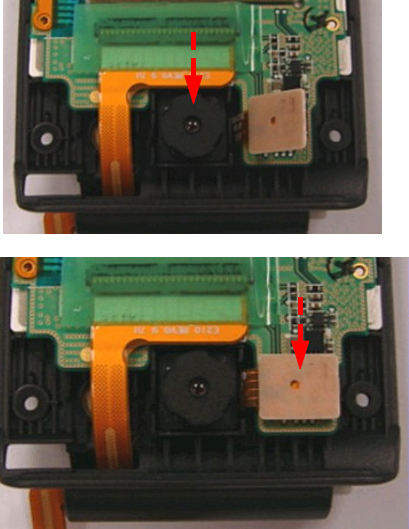
<p>1</p> 	<p>2</p> 
<p>1) LCD Ass'y * caution 1) Be careful not to leave any foreign substance or fingerprint on the SUB-LCD.</p>	<p>1) Insert the LCD FPCB into the hole on the LOWER carefully * caution 1) Be careful not to damage the FPCB.</p>
<p>3</p> 	<p>4</p> 
<p>1) Put the LCD Ass'y into place as shown. 2) Put the speaker and motor into place. * caution 1) Adjust a tape before putting the LCD. 2) Be careful not to break wires.</p>	<p>1) Put the camera into place. 2) As shown, put the connector until it clicks * caution 1) Be careful not to touch the camera lens. 2) Press the connector until it clicks.</p>

5

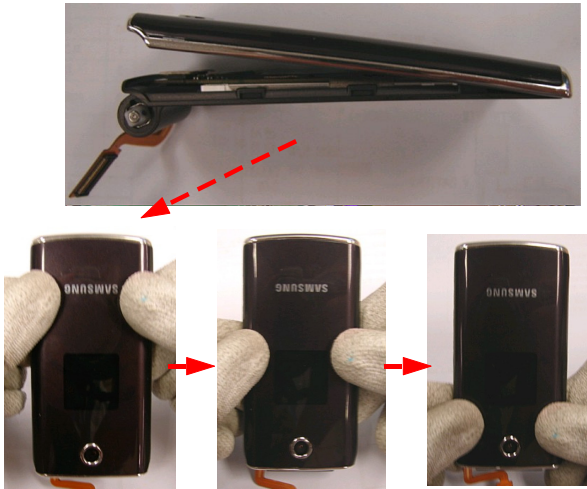

1) Assembling the FOLDER should be done in regular sequence as shown.(TOP-> BOTH SIDES OF THE LCD ->BOTH SIDES OF THE SUB-LCD-> BOTTOM)

*** caution**

- 1) Check if there are not any foreign substance.
- 2) Be careful not to make scratch and damage.

6

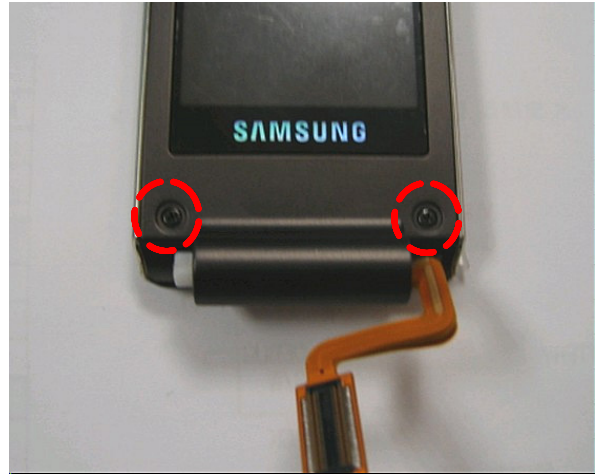

1) Tighten 2 screws.

*** caution**

- 1) Be careful not to make scratch and damage.

7



1) Put up screw sheets.

*** caution**

- 1) Be careful not to make scratch and damage.

8



1) Insert the FPCB of the FOLDER ASS'Y assembled.

*** caution**

- 1) Be careful not to make scratch and damage.

9



1) Set the FRONT ASS'Y into the hole after pressing the HINGE.
 ※ **caution**
 1) Be careful not to make scratch and damage.

10

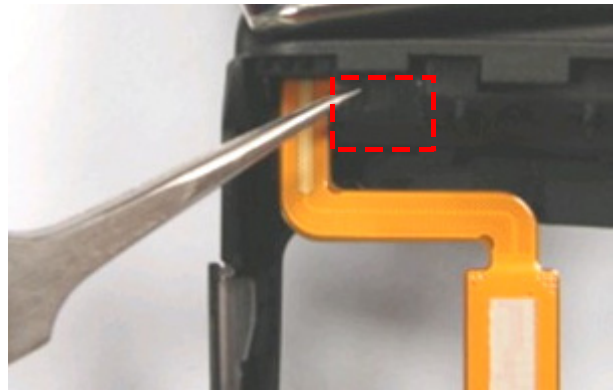

1) Put up the tape.
 ※ **caution**
 1) The tape should not be on the FPCB.

11

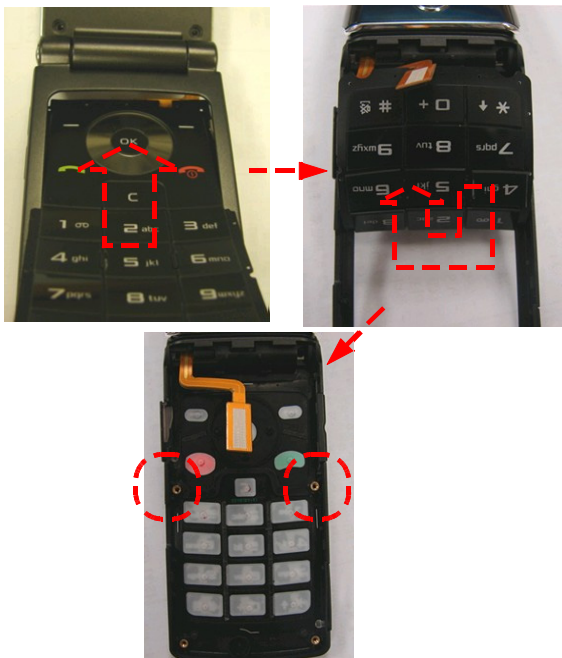

1)As shown in the above picture, insert the upper keypad first,and reverse the phone. Fit the lower keypad in carefully by folding and unfolding it.
 ※ **caution**
 1) Be careful not to fold the keypad.

12

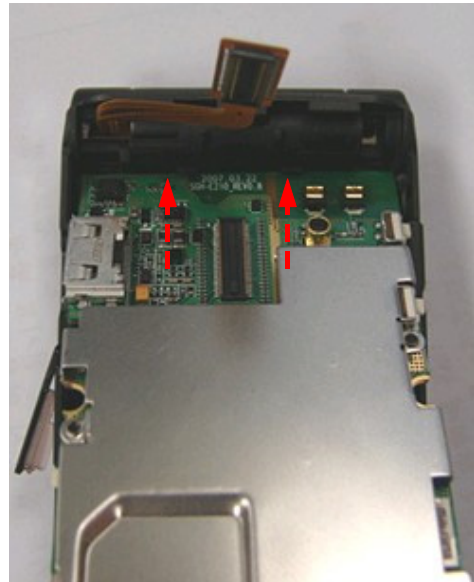

1) Put the PBA in from inserting the upper PBA , as shown.
 ※ **caution**
 1) Make sure of adjusting the right-side keys (volume and camera keys) and left-side earphone jack cover when putting the PBA in.

13

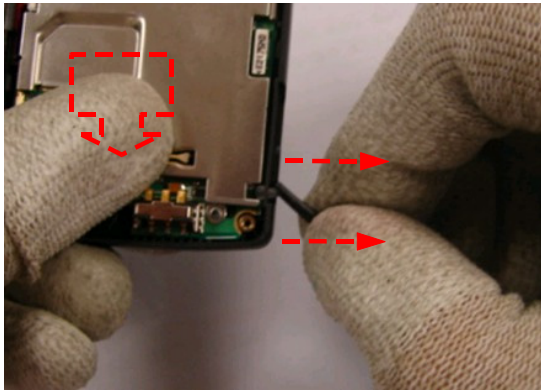

1) Press the PBA while pulling the cover of Micro SD.

*** caution**

1) Make sure of adjusting the Micro SD before pressing the PBA.

14

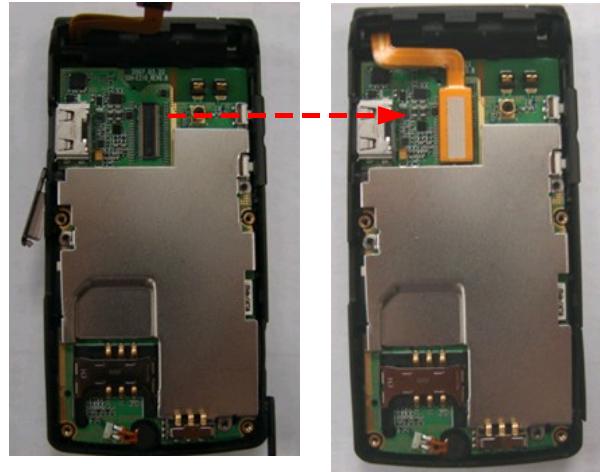

1) Fit the LCD connector into the PBA.

*** caution**

1) Press the connector until it clicks.

2) When pressing the connector, be careful not to break the neighbor components.

15

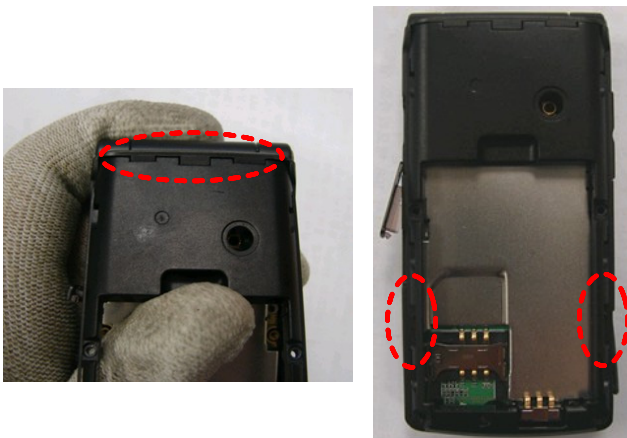

1) Insert the top of the REAR carefully first, and press the bottom.

*** caution**

1) Be careful not to make scratch and damage.

16



1) Tighten 4 screws.

*** caution**

1) Be careful not to make any scratch and damage

8. Block Diagrams

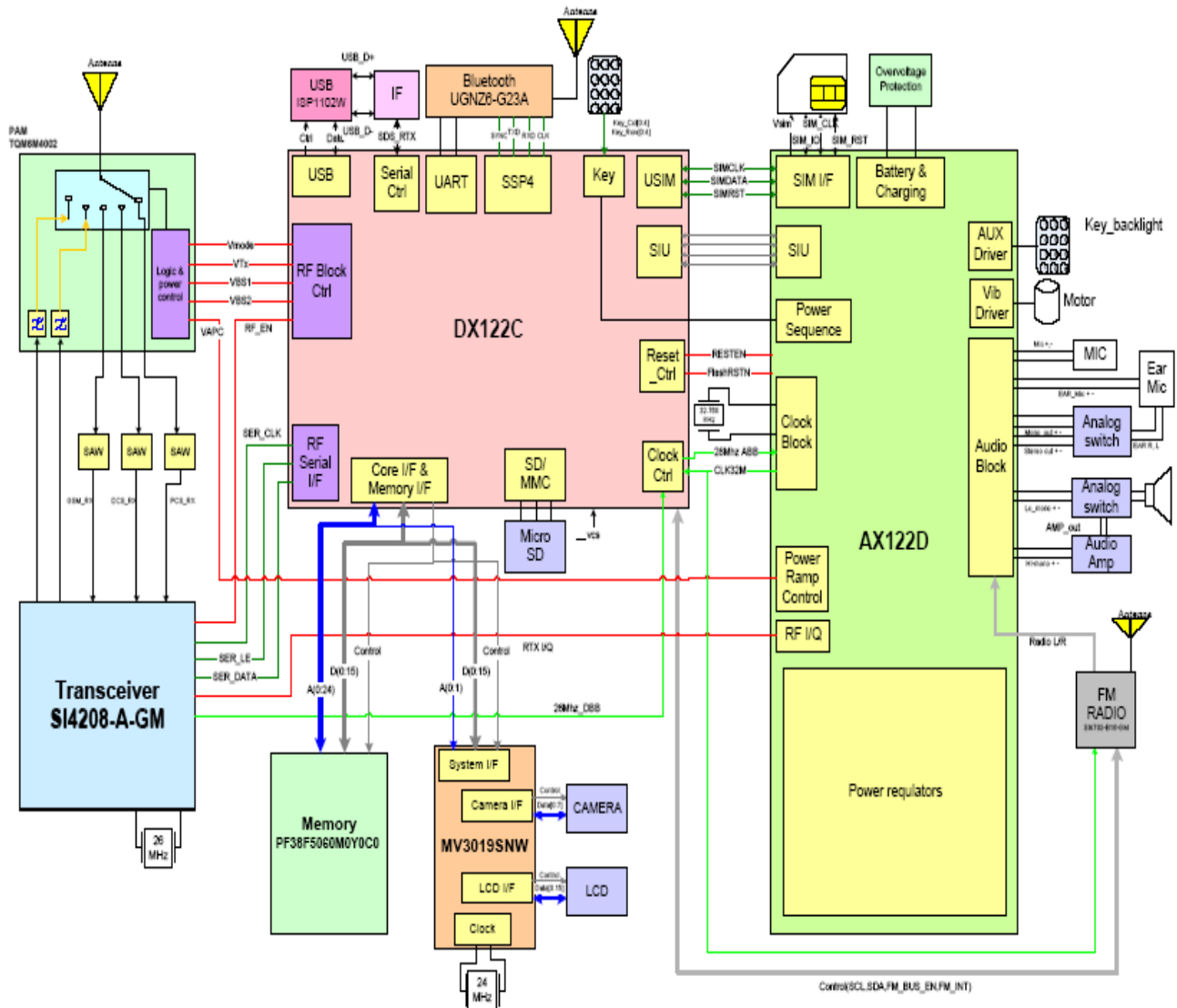

9. PCB Diagrams

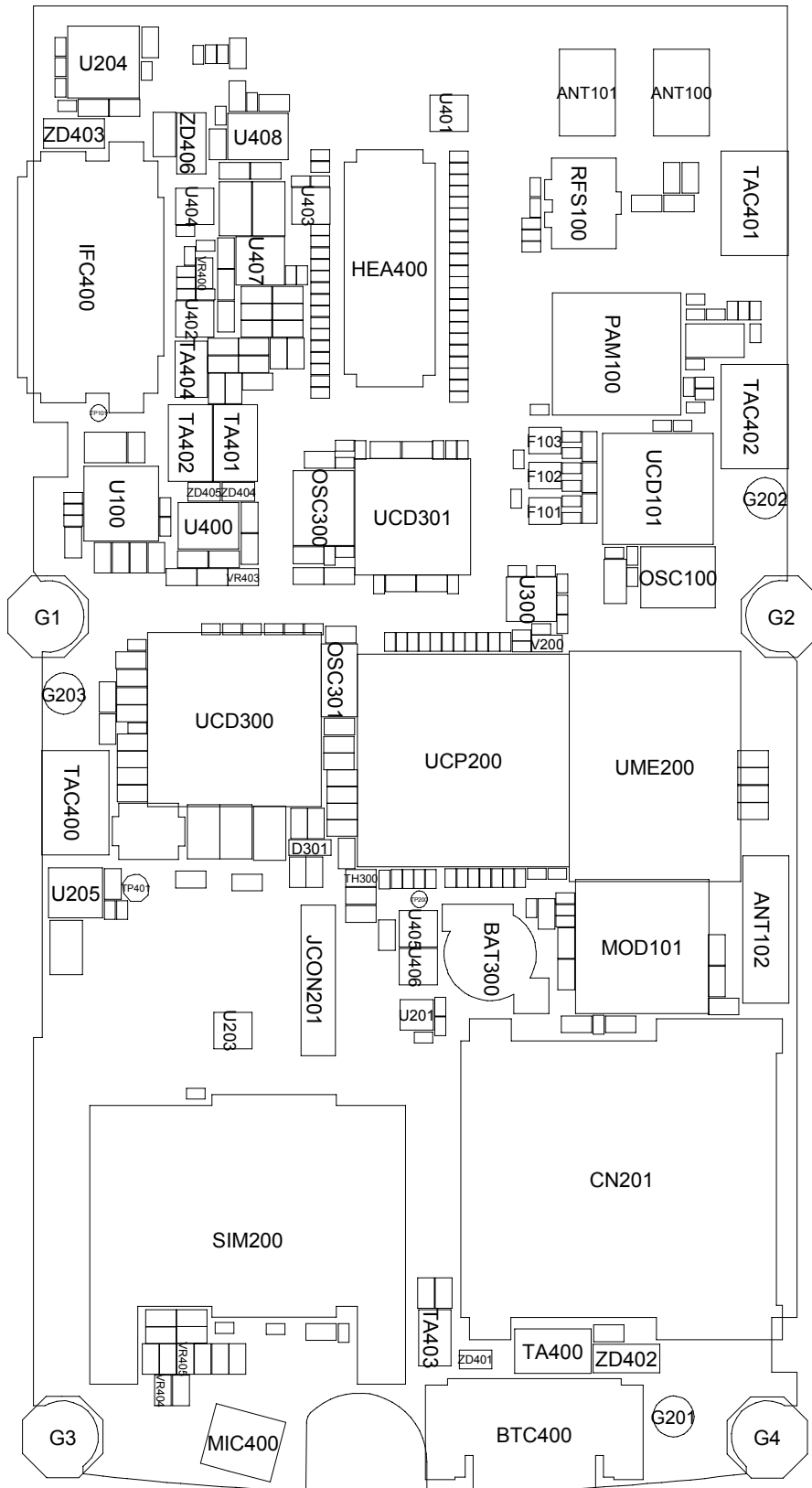

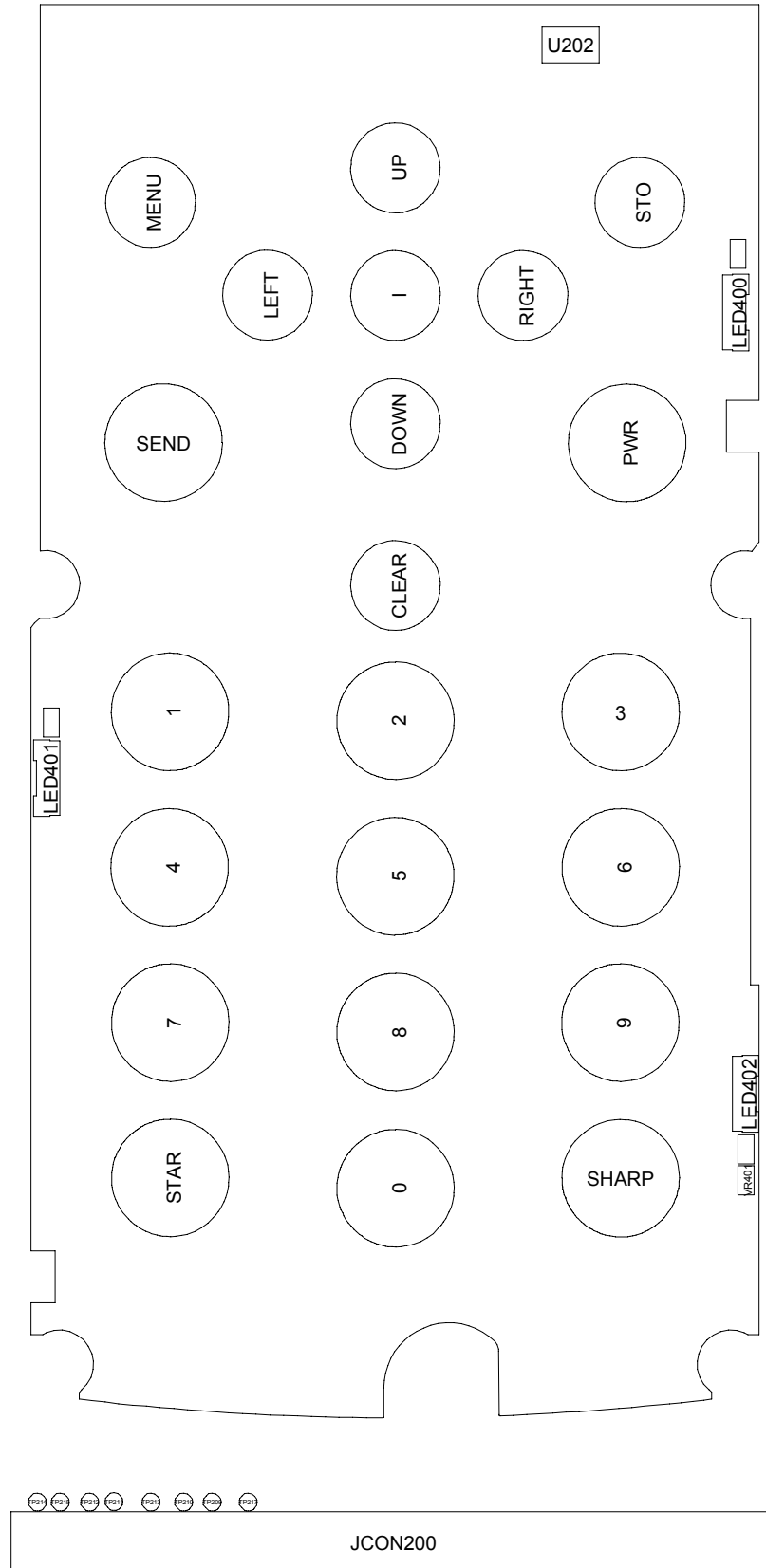

10. Flow Chart of Troubleshooting

10-1. Baseband

10-1-1. Power ON

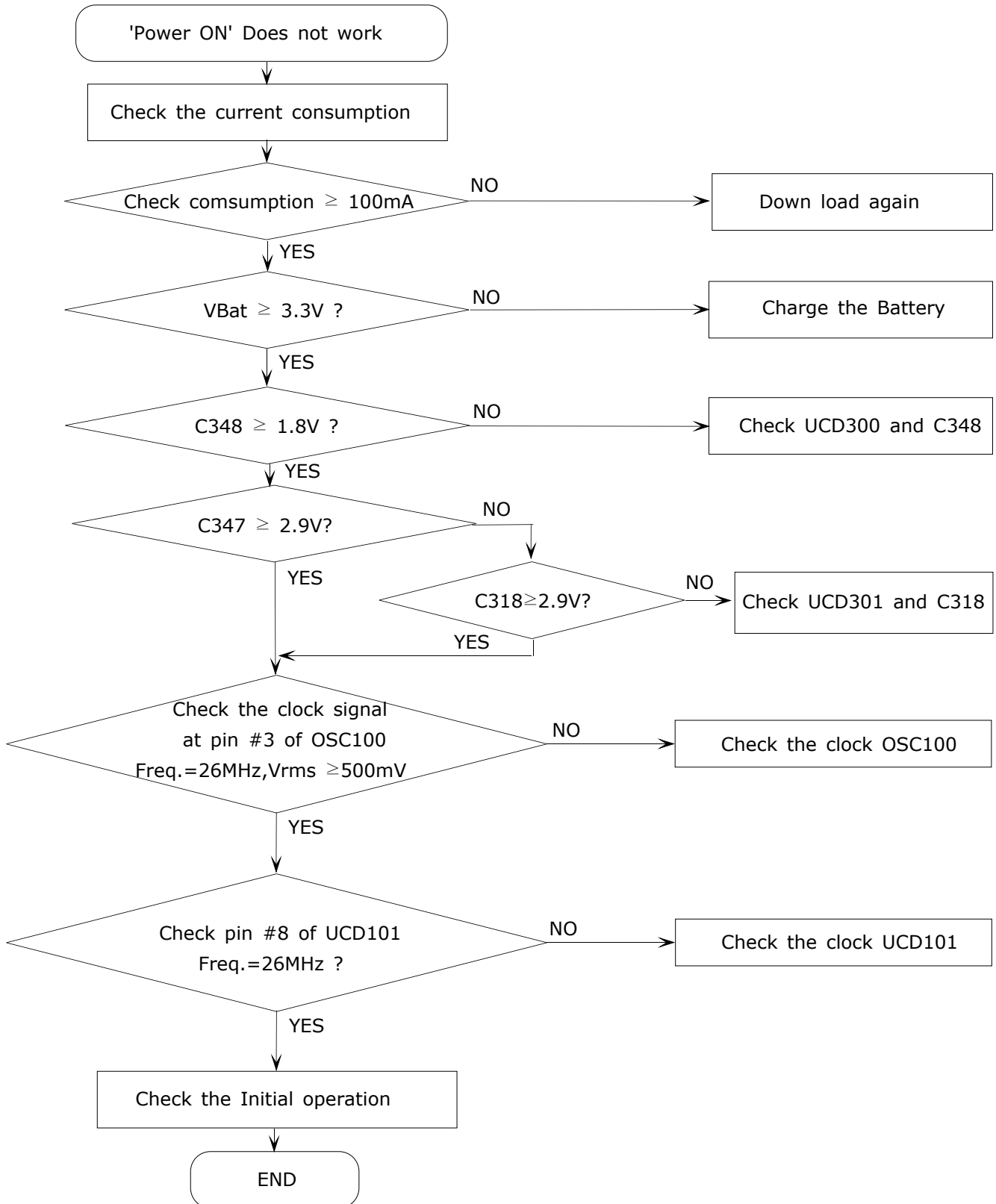

10-1-2. Initial

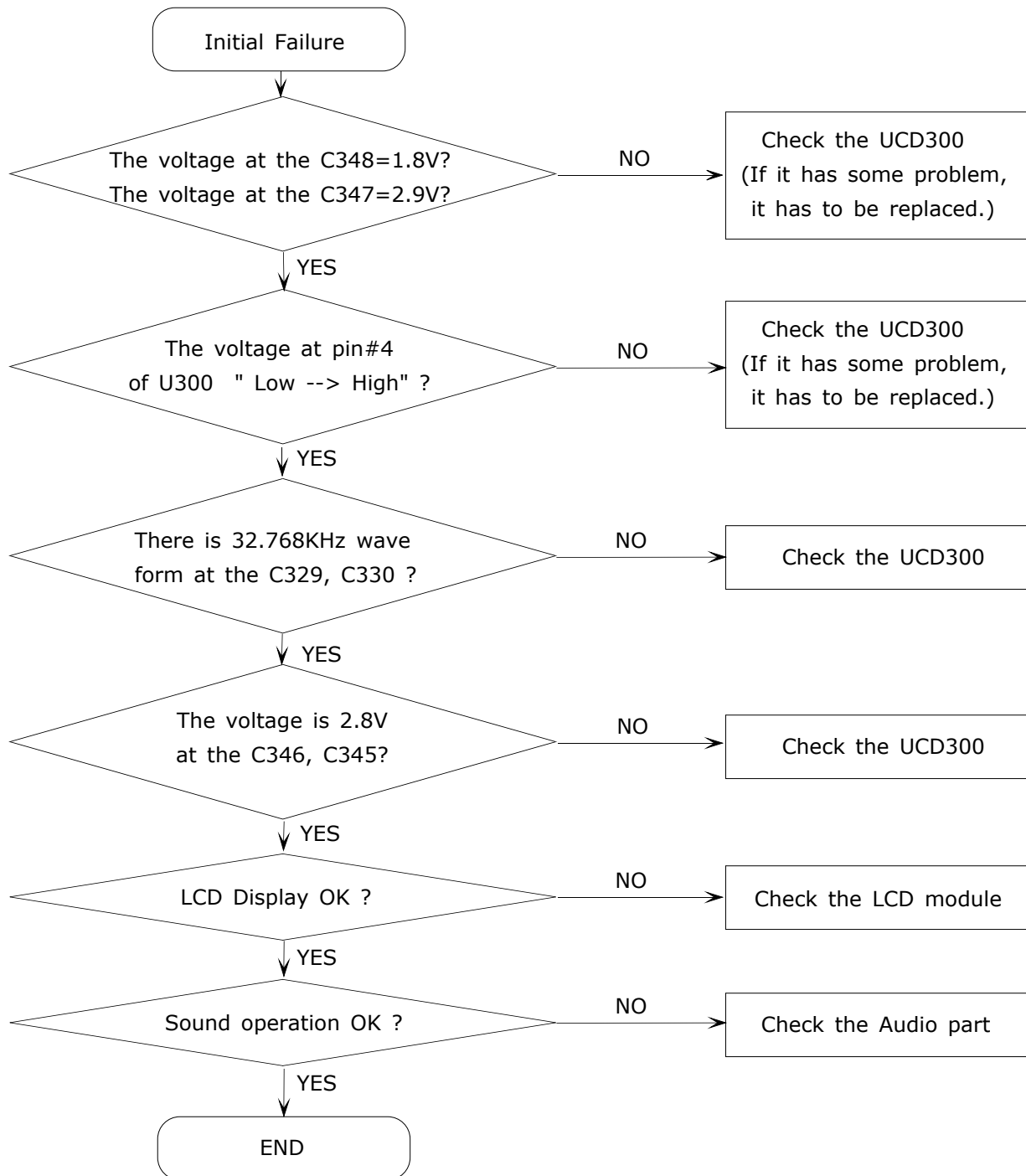

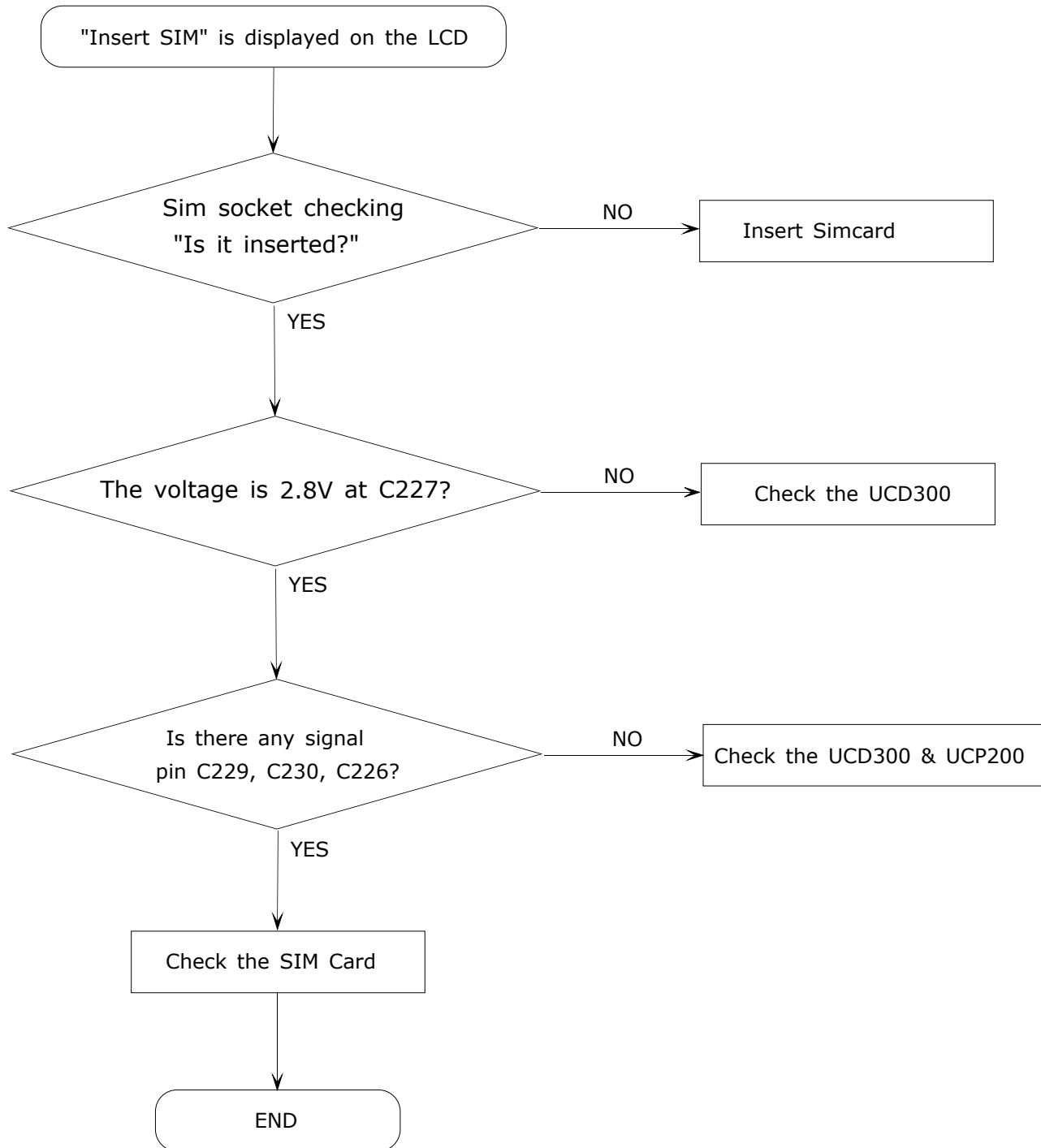
10-1-3. Sim Part

10-1-4. LCD Display part

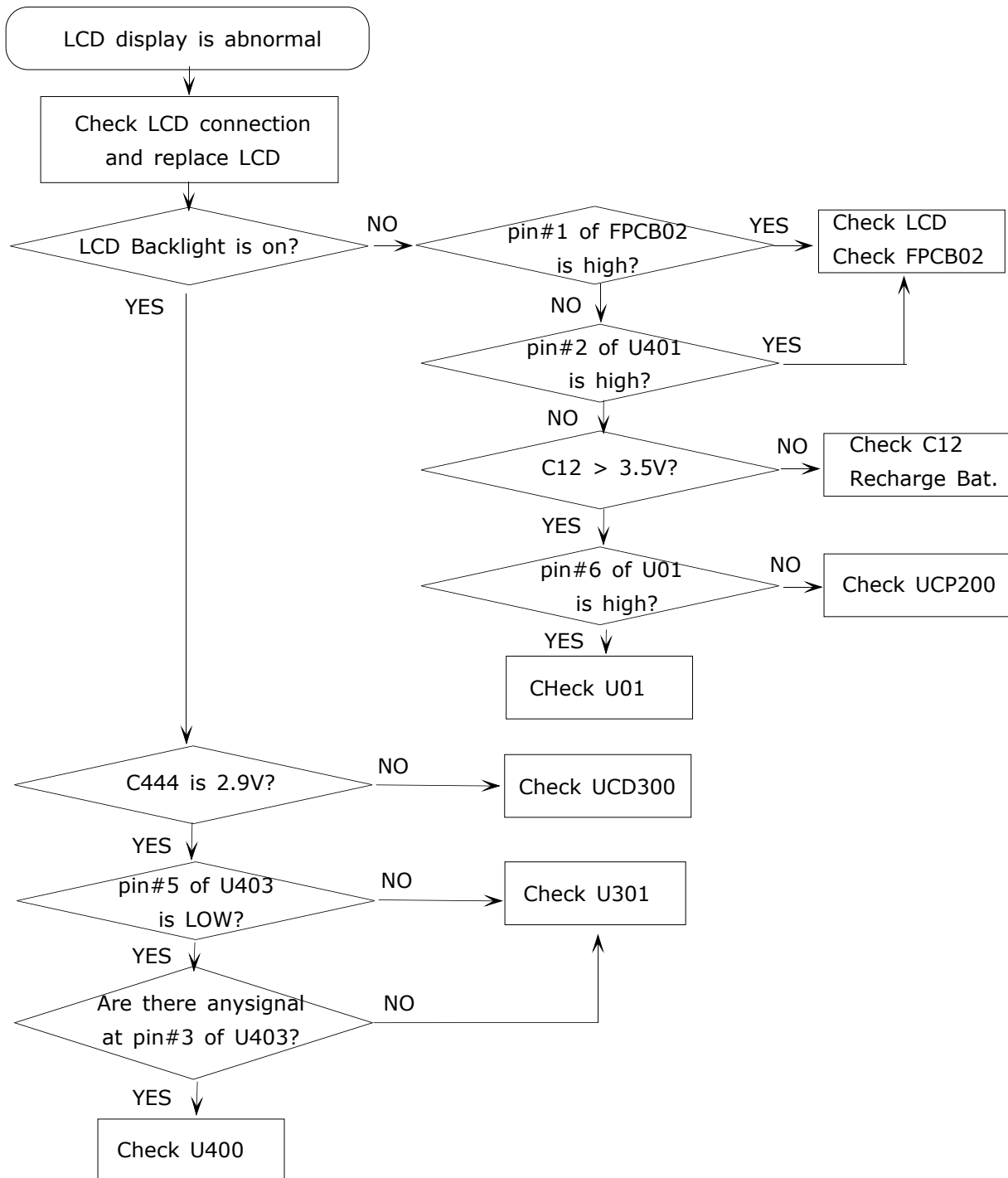

10-1-5. Microphone Part

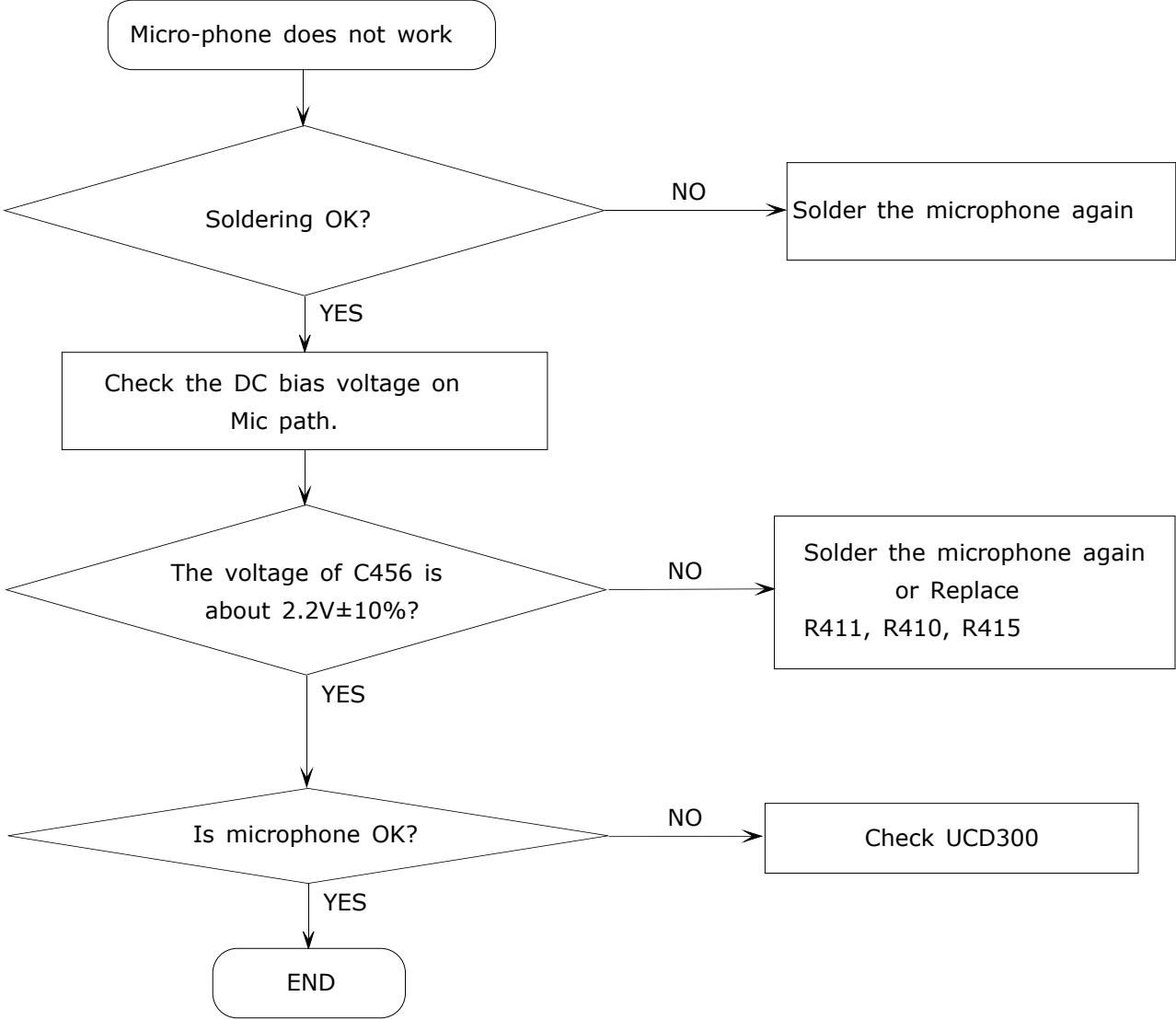

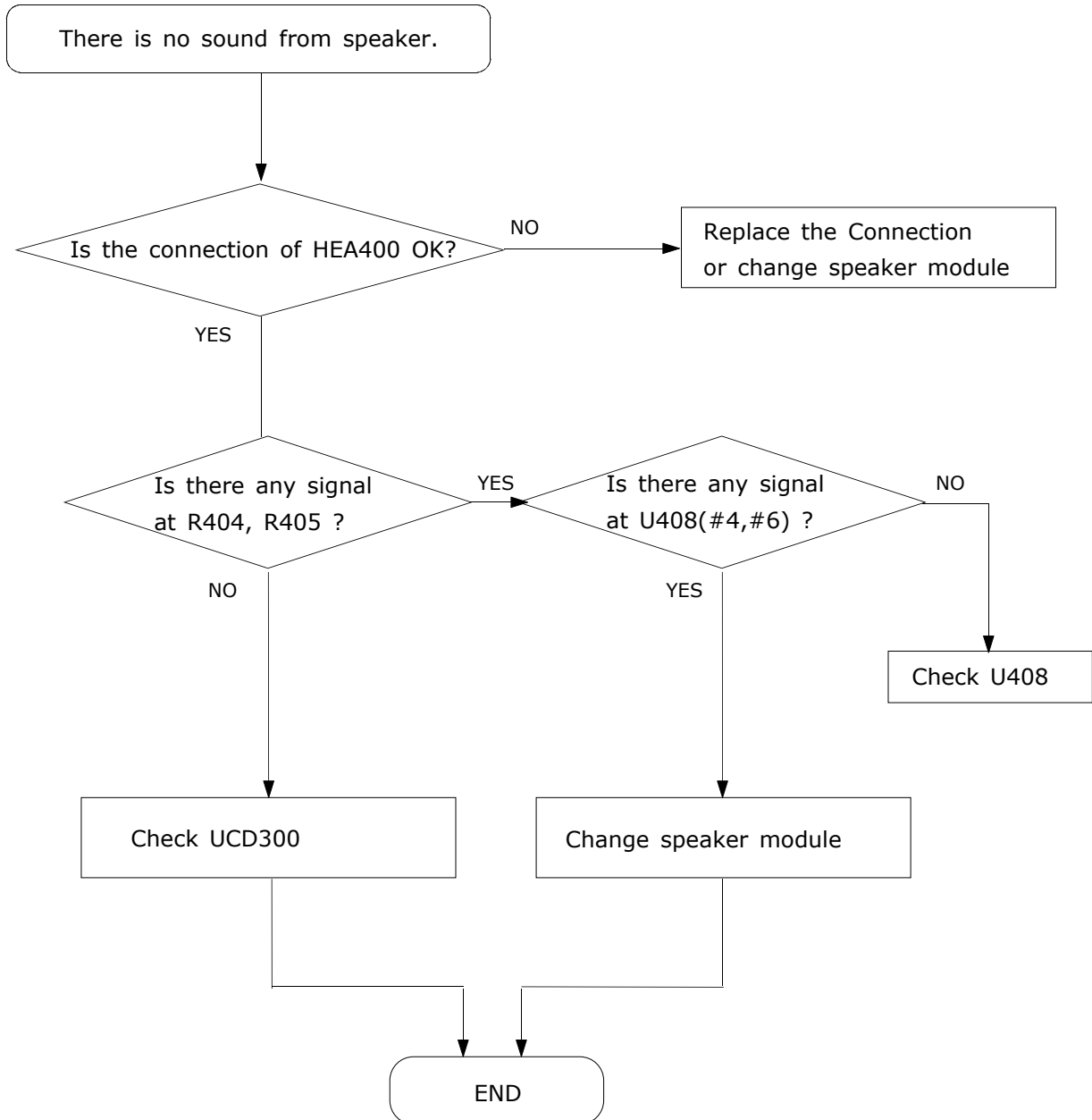
10-1-6. Speaker Part

10-1-7. Camera part

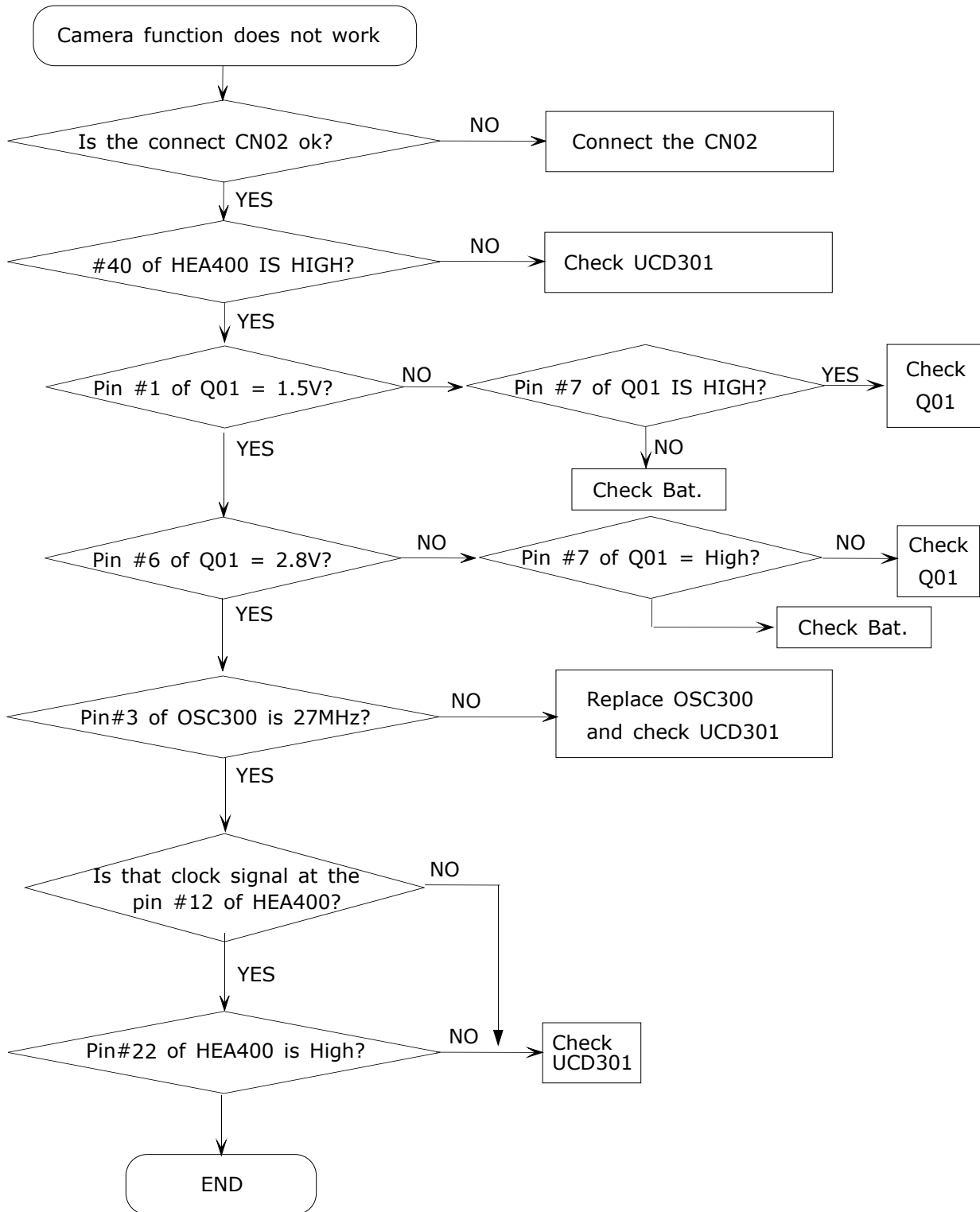

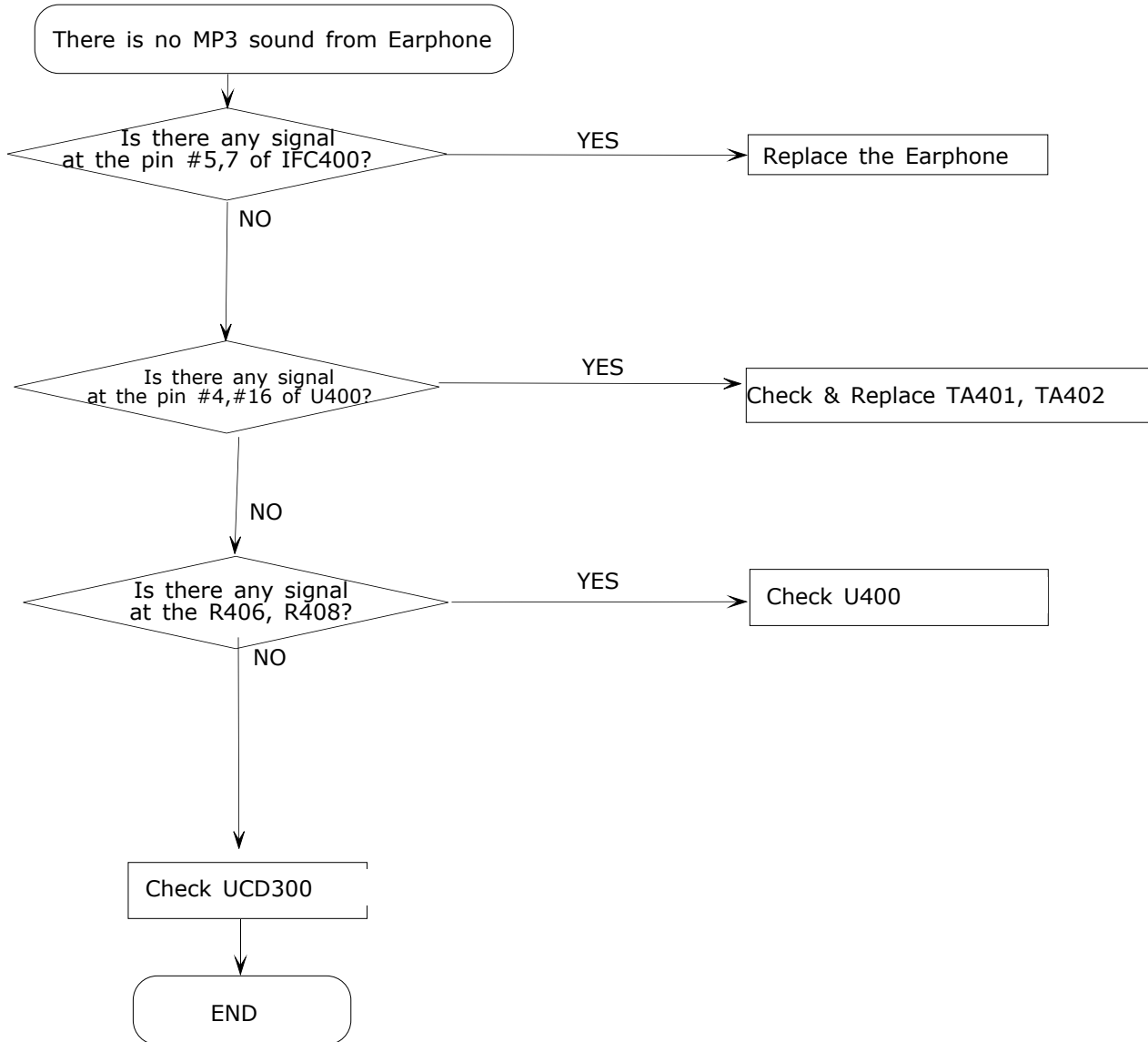
10-1-8. Mp3 part

10-2. RF

10-2-1. GSM900/GSM1800/GSM1900 RX

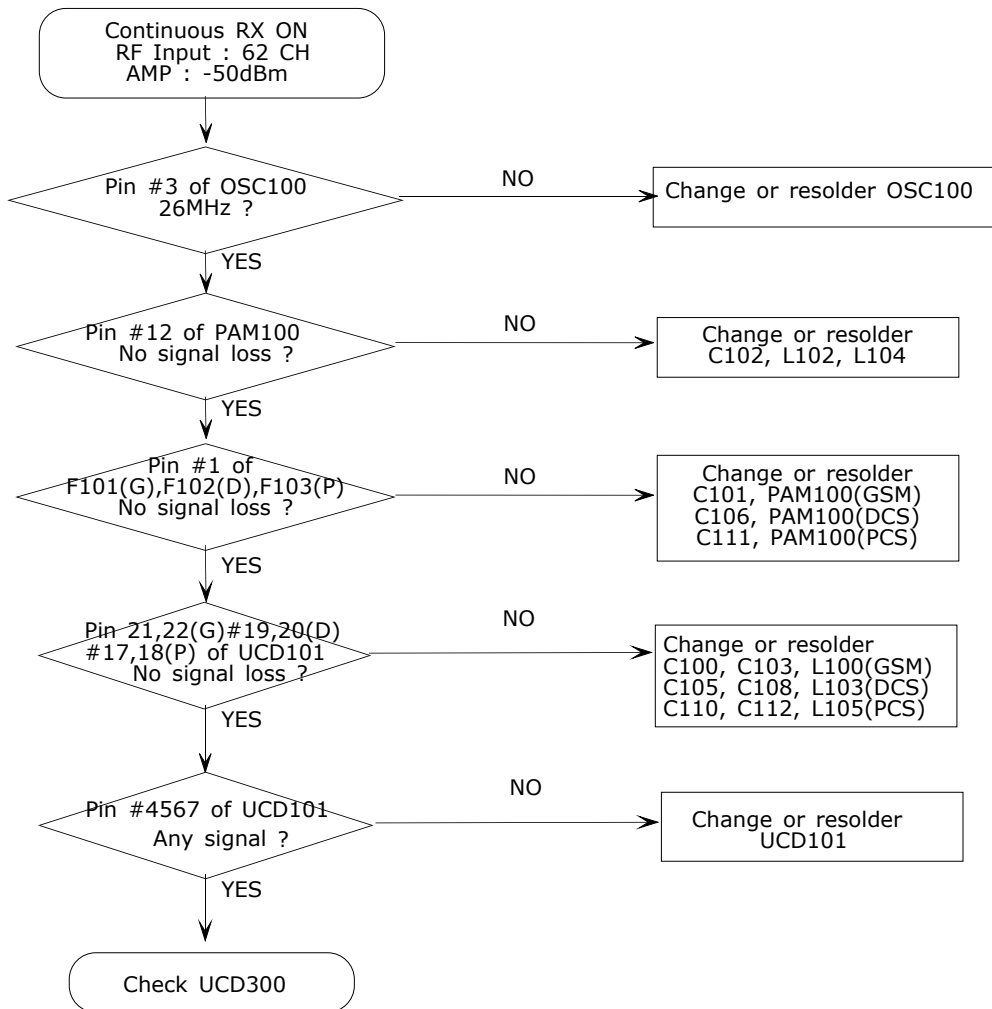

10-2-2. GSM900 TX

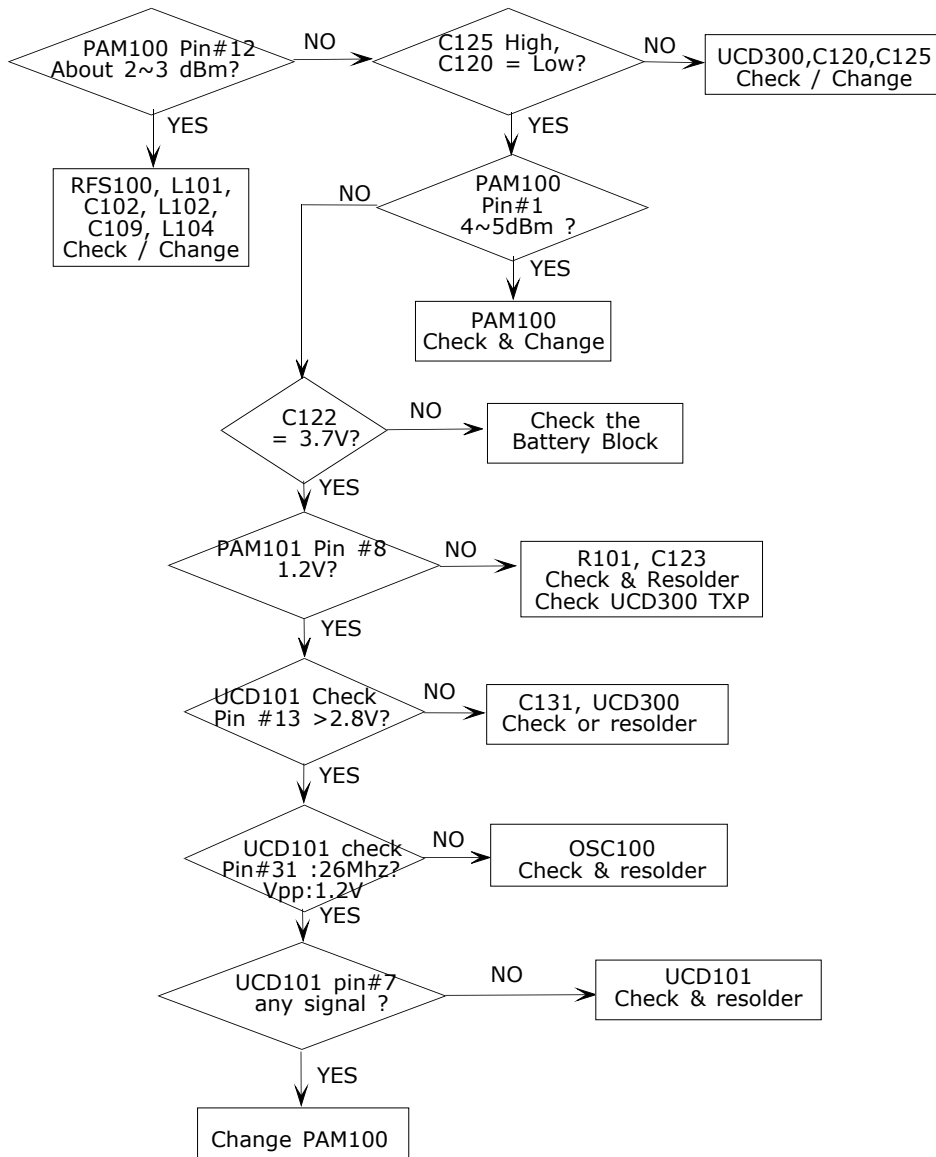

10-2-3. DCS1800 & PCS1900 TX

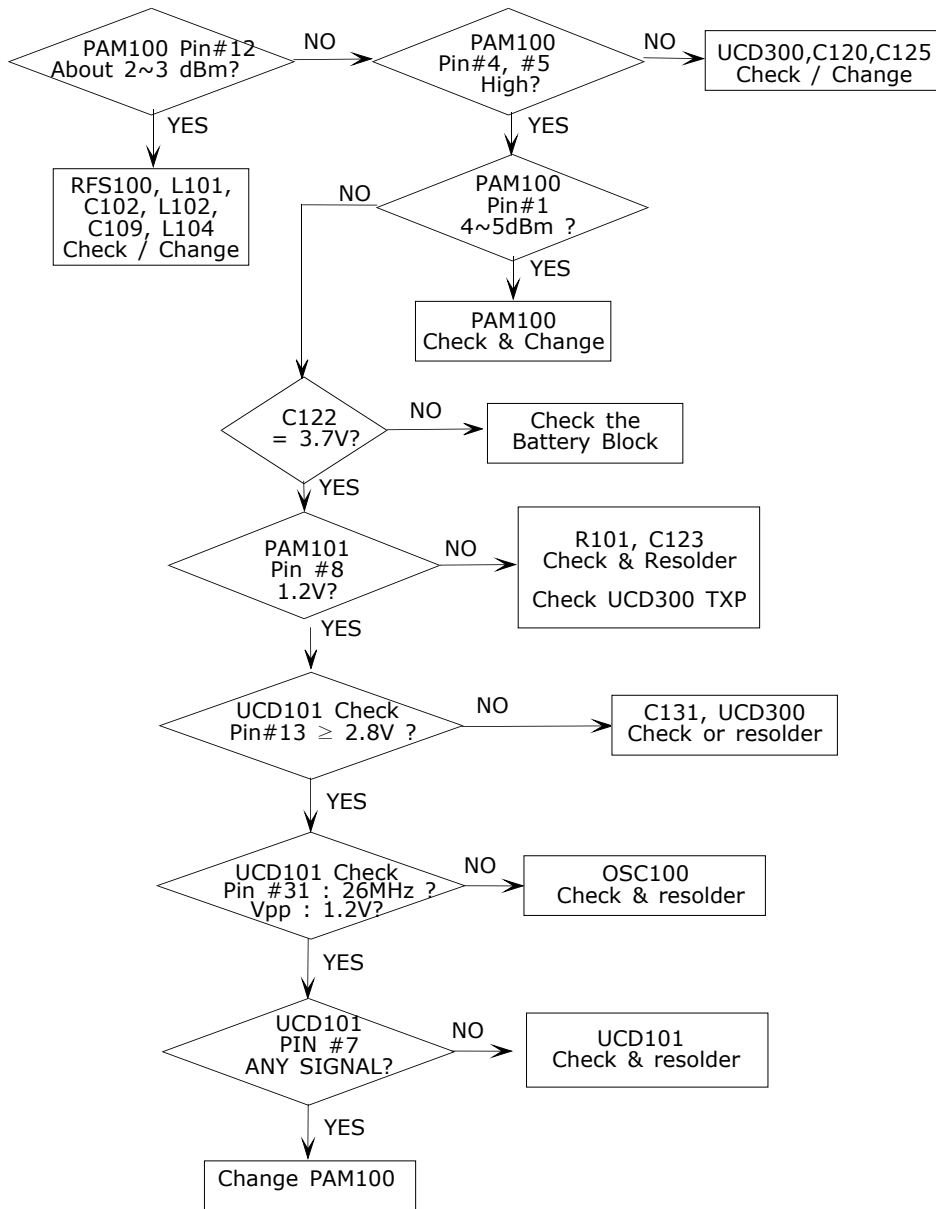

11. Reference data

11-1. Reference Abbreviate

AAC: Advanced Audio Coding.

AVC : Advanced Video Coding.

BER : Bit Error Rate

BPSK: Binary Phase Shift Keying

CA : Conditional Access

CDM : Code Division Multiplexing

C/I : Carrier to Interference

DMB : Digital Multimedia Broadcasting

EN : European Standard

ES : Elementary Stream

ETSI: European Telecommunications Standards Institute

MPEG: Moving Picture Experts Group

PN : Pseudo-random Noise

PS : Pilot Symbol

QPSK: Quadrature Phase Shift Keying

RS : Reed-Solomon

SI : Service Information

TDM : Time Division Multiplexing

TS : Transport Stream