

SAMSUNG

GSM TELEPHONE SGH-A517

SERVICE *Manual*

GSM TELEPHONE



CONTENTS

1. Safety Precautions
2. Specification
3. Product Function
4. Array course control
5. Exploded View and Parts List
6. MAIN Electrical Parts List
7. Block Diagrams
8. PCB Diagrams
9. Flow Chart of Troubleshooting
10. Reference data
11. Disassembly and Assembly Instructions

**SAMSUNG
ELECTRONICS**



GSPN (Global Service Partner Network)

Country	Web Site
North America	service.samsungportal.com
Latin America	latin.samsungportal.com
CIS	cis.samsungportal.com
Europe	europe.samsungportal.com
China	china.samsungportal.com
Asia	asia.samsungportal.com
Mideast & Africa	mea.samsungportal.com

1. Safety Precautions

1-1. Repair Precaution

- Repair in Shield Box, during detailed tuning.
Take specially care of tuning or test,
because specificity of cellular phone is sensitive for surrounding interference(RF noise).
- Be careful to use a kind of magnetic object or tool,
because performance of parts is damaged by the influence of magnetic force.
- Surely use a standard screwdriver when you disassemble this product,
otherwise screw will be worn away.
- Use a thicken twisted wire when you measure level.
A thicken twisted wire has low resistance, therefore error of measurement is few.
- Repair after separate Test Pack and Set because for short danger (for example an
overcurrent and furious flames of parts etc) when you repair board in condition of
connecting Test Pack and tuning on.
- Take specially care of soldering, because Land of PCB is small and weak in heat.
- Surely tune on/off while using AC power plug, because a repair of battery charger is
dangerous when tuning ON/OFF PBA and Connector after disassembling charger.
- Don't use as you pleases after change other material than replacement registered on SEC System.
Otherwise engineer in charge isn't charged with problem that you don't keep this rules.

1-2. ESD(Electrostatically Sensitive Devices) Precaution

Several semiconductor may be damaged easily by static electricity. Such parts are called by ESD (Electrostatically Sensitive Devices), for example IC,BGA chip etc. Read Precaution below.

You can prevent from ESD damage by static electricity.

- Remove static electricity remained your body before you touch semiconductor or parts with semiconductor. There are ways that you touch an earthed place or wear static electricity prevention string on wrist.
- Use earthed soldering steel when you connect or disconnect ESD.
- Use soldering removing tool to break static electricity. , otherwise ESD will be damaged by static electricity.
- Don't unpack until you set up ESD on product. Because most of ESD are packed by box and aluminum plate to have conductive power,they are prevented from static electricity.
- You must maintain electric contact between ESD and place due to be set up until ESD is connected completely to the proper place or a circuit board.

2. Specification

2-1. GSM General Specification

	GSM900 Phase 1	EGSM 900 Phase 2	DCS1800 Phase 1	PCS1900
Freq. Band[MHz] Uplink/Downlink	890~915 935~960	880~915 925~960	1710~1785 1805~1880	1850~1910 1930~1990
ARFCN range	1~124	0~124 & 975~1023	512~885	512~810
Tx/Rx spacing	45MHz	45MHz	95MHz	80MHz
Mod. Bit rate/ Bit Period	270.833kbps 3.692us	270.833kbps 3.692us	270.833kbps 3.692us	270.833kbps 3.692us
Time Slot Period/Frame Period	576.9us 4.615ms	576.9us 4.615ms	576.9us 4.615ms	576.9us 4.615ms
Modulation	0.3GMSK	0.3GMSK	0.3GMSK	0.3GMSK
MS Power	33dBm~5dBm	33dBm~5dBm	30dBm~0dBm	30dBm~0dBm
Power Class	5pcl ~ 19pcl	5pcl ~ 19pcl	0pcl ~ 15pcl	0pcl ~ 15pcl
Sensitivity	-102dBm	-102dBm	-100dBm	-100dBm
TDMA Mux	8	8	8	8
Cell Radius	35Km	35Km	2Km	-

2-2. GSM Tx Power Class

TX Power control level	GSM900	TX Power control level	DCS1800	TX Power control level	PCS1800
5	33±2 dBm	0	30±3 dBm	0	30±3 dBm
6	31±2 dBm	1	28±3 dBm	1	28±3 dBm
7	29±2 dBm	2	26±3 dBm	2	26±3 dBm
8	27±2 dBm	3	24±3 dBm	3	24±3 dBm
9	25±2 dBm	4	22±3 dBm	4	22±3 dBm
10	23±2 dBm	5	20±3 dBm	5	20±3 dBm
11	21±2 dBm	6	18±3 dBm	6	18±3 dBm
12	19±2 dBm	7	16±3 dBm	7	16±3 dBm
13	17±2 dBm	8	14±3 dBm	8	14±3 dBm
14	15±2 dBm	9	12±4 dBm	9	12±4 dBm
15	13±2 dBm	10	10±4 dBm	10	10±4 dBm
16	11±3 dBm	11	8±4dBm	11	8±4dBm
17	9±3dBm	12	6±4 dBm	12	6±4 dBm
18	7±3 dBm	13	4±4 dBm	13	4±4 dBm
19	5±3 dBm	14	2±5 dBm	14	2±5 dBm
		15	0±5 dBm	15	0±5 dBm

3. Product Function

Main Function

- *Concept : Stylish Slim Folder*
- **EDGE Class 10**
- **Quad Band 850/900/1800/1900 MHz**
- **Dimension : 102 x 51.5 x 15.9mm**
- **Display : [Int] 2.1" 176 x 220 pixel 262K TFT
[Ext] 1.0" 96 x 96 pixel 4 Gray**
- **Camera: 1.3 Mega Camera**
- **Ringtones : MP3, AAC, MIDI/ 64 Polyphonic**
- **Music Player : MP3, AAC, AAC+, eAAC WMA**
- **Video Recording : H.263, MPEG-4**

- **Messaging : Video Msg.(300KB), IM (MSN, Yahoo, AOL), Mobile Email (Oz)**
- **Java MIDP 2.0 / CLDC 1.1**
- **DRM: WMDRM with MTP**
- **Connectivity : USB 2.0, Bluetooth v2.0**
- **External Memory : microSD**
- **SyncML DM / FOTA**
- **Speaker Phone, SAIC**
- **Battery: 800mAh**

4. Array course control

4-1. Software Downloading

Test Jig (GH80-03306A)

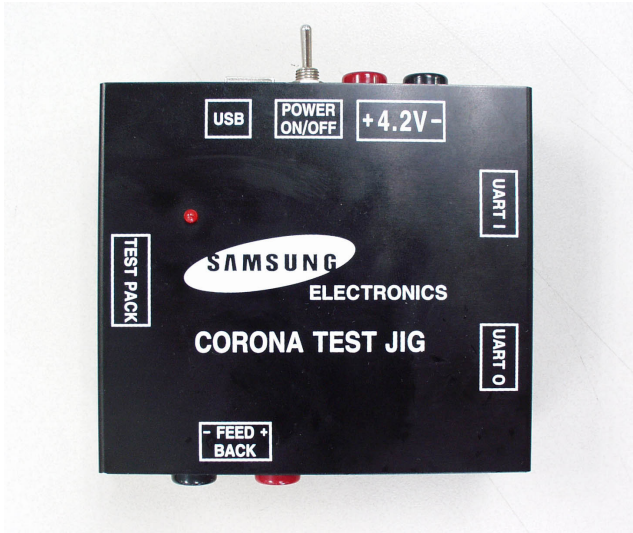

SGH-A517 Zig cable

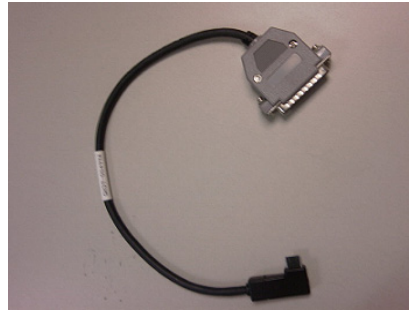

Serial Cable(CSA LL64151-A)

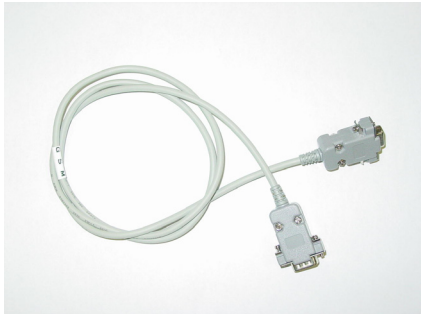

Power Supply Cable

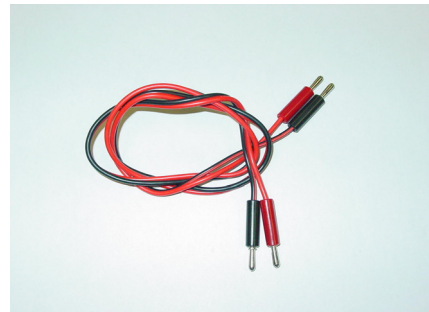

4-2. Software Downloading

4-2-1. Pre-requisite for Downloading

- Downloader Program([OneNAND Downloader V1.2 Lite For PNX5230.exe](#))
- SGH-A517 Mobile Phone
- Data Cable
- Binary file, TFS file

4-2-2. S/W Downloader Program

■ Load the binary download program by executing the
“[OneNAND Downloader V1.2 Lite For PNX5230.exe](#)”

1. Select the connected serial port and the rate of speed
2. Select the check box, the mode you want to download.
 - if the binary file wanted, check only 'BIN'
 - if the tfs file wanted, check only 'TFS'
 - if all the files wanted, check 'BIN+TFS'

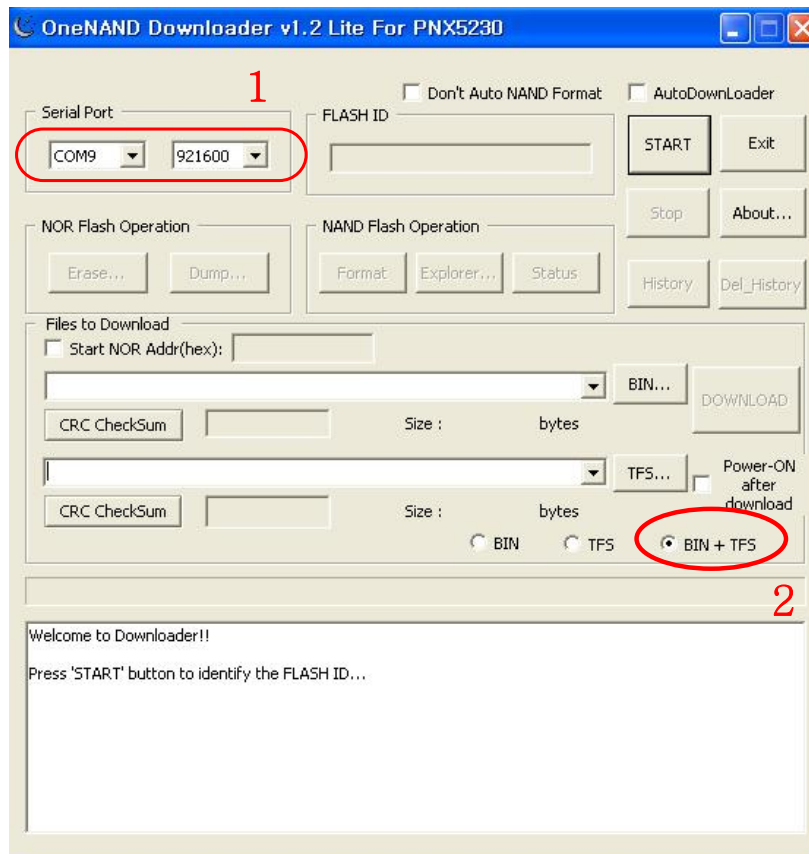

3. Select the file(s) what you want to download

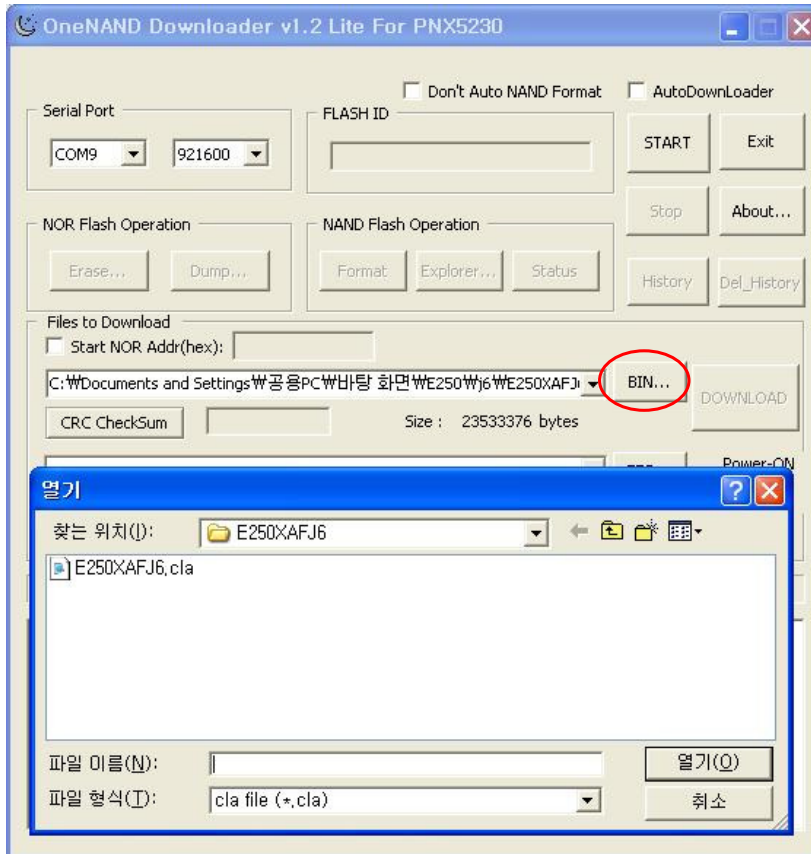

5. Exploded View and Parts List

5-1. Cellular phone Exploded View

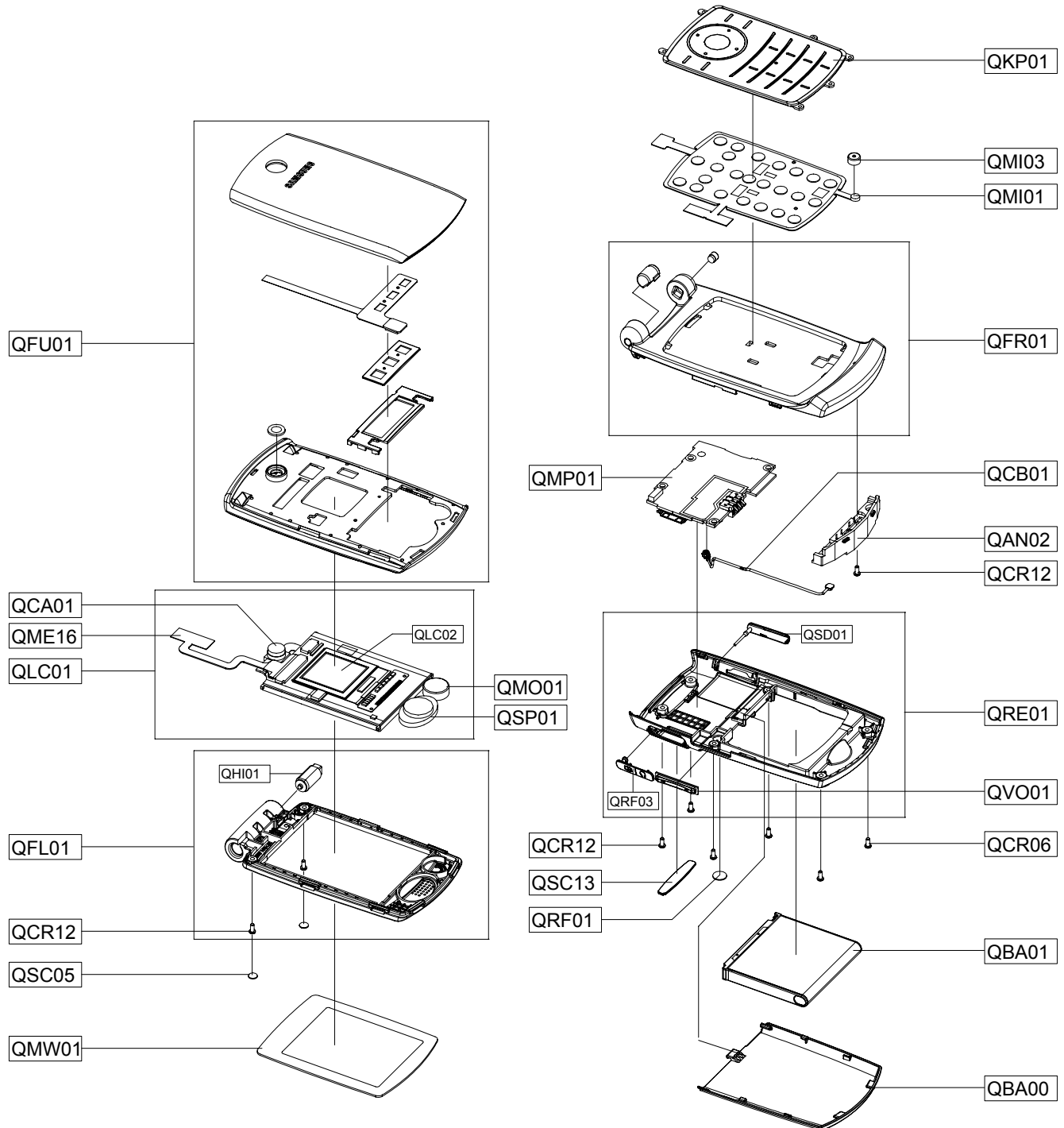

5-2. Cellular phone Parts list

Design LOC		Description	SEC Code	
QAN02		INTENNA-SGH A517	GH42-01221A	
QBA00		PMO CASE-BATTERY V2	GH72-41887A	
QBA01		INNER BATTERY PACK-800MAH , BL	GH43-02845A	
QCA01		CAMERA MODULE	GH59-04425A	
QCB01		CBF COAXIAL CABLE	GH39-00403A	
QCR06		SCREW-MACHINE	6001-001155	
QCR12		SCREW-MACHINE	6001-001530	
QCR12		SCREW-MACHINE	6001-001530	
QFR01		ASSY CASE-FRONT	GH98-06354A	
QFU01		ASSY CASE-FOLDER UPPER	GH98-04485A	
QME16		ASSY ETC-CON TO CON FPCB	GH59-04424A	
QMO01		MOTOR DC-SGH A517	GH31-00344A	
QMP01		PBA MAIN-SGH A517	GH92-03721A	
QMW01		ASSY COVER-MAIN WINDOW	GH98-05300A	
QRF01		TAPE-RF HOLE SHEET	GH74-31422A	
QSC05		TAPE-LOWER SCREW CAP	GH74-31416A	
QSC13		ASSY COVER-REAR SCREW CAP	GH98-05301A	
QSP01		SPEAKER	3001-002197	
QVO01		PMO KEY-VOLUME V2	GH72-41891A	
QRE01		ASSY CASE-REAR	GH98-04488A	
	QSD01	PMO COVER-SD V2	GH72-41888A	
	QRF03	PMO COVER-EAR V2	GH72-41889A	
QLC01		ELA ETC-A517 LCD MODULE	GH96-02597A	
	QLC02	LCD-SUB SGH A517	GH07-01167A	
QFL01		ASSY CASE-FOLDER LOWER	GH98-04486A	
	QHI01	ASSY HINGE-HINGE	GH98-03755A	
	QKP01	ASSY KEYPAD-(ATT/BLK)	GH98-04489A	
		QMI01	AS-MIC SVC	GH81-05445A
		QMI03	AS-SGH A517 MIC RUBBER	GH81-06822A

Description	SEC Code
BAG PE	6902-000634
ADAPTOR-SGH_T419 BLK	GH44-01700A
ASSY ETC-LED BACK LIGHT	GH59-04283A
ASSY ETC-LCD MAIN PBA	GH59-04493A
ASSY ETC-LCD IF PBA	GH59-04494A
UNIT-TOUCH KEY MODULE ASS'Y	GH59-04831A
LABEL(R)-WATERSOAK(NEW)	GH68-14285A
LABEL(R)-MAIN(ATT)	GH68-14533A
BOX-SPACE AT&T	GH69-05279A
CUSHION-CASE(ATT)	GH69-05280A
BOX-UNIT(ATT)	GH69-05309A
MPR-REMOVE TAPE LCD	GH74-13804A
MPR-TAPE LED	GH74-17926A
MPR-TAPE	GH74-27509A
MPR-INSU TAPE SUB LCD	GH74-27510A
MPR-INSU TAPE	GH74-27511A
MPR-INSU TAPE	GH74-27512A
TAPE-LCD CON GASKET	GH74-31423A
MPR-INSU TAPE LCD	GH74-31428A
VINYL-BOHO UPPER	GH74-33034A
TAPE-FRONT SHIELD	GH74-33037A
TAPE GASK-LCD SUB	GH74-33038A
TAPE-CAMERA CON	GH74-33422A
SPONGE	GH74-34124A
VINYL-BOHO MAIN WINDOW	GH74-35143A
PAA ETC-MANUAL(ATT)	GH99-23669A

6. MAIN Electrical Parts List

Design LOC	Description	SEC Code	STATUS
ANT100	ANTENNA-CHIP	4202-001326	SA
BTC700	CONNECTOR-BATTERY	3711-006003	SA
C101	C-CER,CHIP	2203-000233	SA
C103	C-CER,CHIP	2203-000233	SA
C104	C-CER,CHIP	2203-000233	SA
C111	C-CER,CHIP	2203-006305	SA
C114	C-CER,CHIP	2203-005736	SA
C116	C-CER,CHIP	2203-006423	SA
C117	C-CER,CHIP	2203-001221	SA
C118	C-CER,CHIP	2203-005482	SA
C119	C-CER,CHIP	2203-005482	SA
C122	C-CER,CHIP	2203-000438	SA
C148	C-CER,CHIP	2203-000233	SA
C149	C-CER,CHIP	2203-000233	SA
C150	C-CER,CHIP	2203-000233	SA
C151	C-CER,CHIP	2203-005482	SA
C152	C-CER,CHIP	2203-000812	SA
C153	C-CER,CHIP	2203-005482	SA
C154	C-CER,CHIP	2203-006838	SA
C155	C-CER,CHIP	2203-001385	SA
C156	C-CER,CHIP	2203-006838	SA
C157	C-CER,CHIP	2203-005482	SA
C159	C-CER,CHIP	2203-006838	SA
C160	C-CER,CHIP	2203-000278	SA
C161	C-CER,CHIP	2203-000233	SA
C162	C-CER,CHIP	2203-006842	SA
C164	INDUCTOR-SMD	2703-002200	SA
C165	C-CER,CHIP	2203-000438	SA
C200	C-CER,CHIP	2203-005482	SA
C201	C-CER,CHIP	2203-000812	SA
C202	C-CER,CHIP	2203-000254	SA
C203	C-CER,CHIP	2203-005682	SA
C204	C-CER,CHIP	2203-006423	SA
C205	C-CER,CHIP	2203-006979	SA
C206	C-CER,CHIP	2203-006423	SA

Design LOC	Description	SEC Code	STATUS
C207	C-CER,CHIP	2203-005482	SA
C208	C-CER,CHIP	2203-005482	SA
C209	C-CER,CHIP	2203-000254	SA
C210	C-CER,CHIP	2203-005482	SA
C211	C-CER,CHIP	2203-000812	SA
C212	C-CER,CHIP	2203-005482	SA
C213	C-CER,CHIP	2203-006681	SA
C214	C-CER,CHIP	2203-006626	SA
C215	C-CER,CHIP	2203-005725	SA
C216	C-CER,CHIP	2203-000628	SA
C219	C-CER,CHIP	2203-000812	SA
C220	C-CER,CHIP	2203-005482	SA
C300	C-CER,CHIP	2203-000254	SA
C301	C-CER,CHIP	2203-005482	SA
C302	C-CER,CHIP	2203-005482	SA
C303	C-CER,CHIP	2203-005482	SA
C304	C-CER,CHIP	2203-000254	SA
C305	C-CER,CHIP	2203-005482	SA
C306	C-CER,CHIP	2203-006681	SA
C307	C-CER,CHIP	2203-000425	SA
C308	C-CER,CHIP	2203-000425	SA
C311	C-CER,CHIP	2203-005138	SA
C312	C-CER,CHIP	2203-005138	SA
C313	C-CER,CHIP	2203-005725	SA
C314	C-CER,CHIP	2203-005725	SA
C322	C-CER,CHIP	2203-005482	SA
C325	C-CER,CHIP	2203-000254	SA
C326	C-CER,CHIP	2203-000254	SA
C327	C-CER,CHIP	2203-005482	SA
C328	C-CER,CHIP	2203-000254	SA
C329	C-CER,CHIP	2203-002709	SA
C330	C-CER,CHIP	2203-006260	SA
C331	C-CER,CHIP	2203-006824	SA
C402	C-CER,CHIP	2203-006562	SA
C403	C-CER,CHIP	2203-006257	SA

Main Electrical Parts List

Design LOC	Description	SEC Code	STATUS
C404	C-CER,CHIP	2203-006824	SA
C405	C-CER,CHIP	2203-006890	SA
C406	C-CER,CHIP	2203-006824	SA
C407	C-CER,CHIP	2203-006824	SA
C408	C-CER,CHIP	2203-006348	SA
C409	C-CER,CHIP	2203-006348	SA
C410	C-CER,CHIP	2203-006257	SA
C412	C-CER,CHIP	2203-006257	SA
C414	C-CER,CHIP	2203-006257	SA
C415	C-CER,CHIP	2203-006562	SA
C418	C-CER,CHIP	2203-006562	SA
C420	C-CER,CHIP	2203-006562	SA
C421	C-CER,CHIP	2203-006562	SA
C423	C-CER,CHIP	2203-006257	SA
C424	C-CER,CHIP	2203-000233	SA
C425	BATTERY-LI(2ND)	4302-001181	SA
C426	C-CER,CHIP	2203-000425	SA
C427	C-CER,CHIP	2203-000425	SA
C432	C-CER,CHIP	2203-006257	SA
C433	C-CER,CHIP	2203-006324	SA
C434	C-CER,CHIP	2203-005482	SA
C443	C-CER,CHIP	2203-006562	SA
C446	C-CER,CHIP	2203-006562	SA
C447	C-CER,CHIP	2203-006562	SA
C448	C-CER,CHIP	2203-006562	SA
C449	C-CER,CHIP	2203-006890	SA
C450	C-CER,CHIP	2203-005061	SA
C451	C-CER,CHIP	2203-006562	SA
C452	C-CER,CHIP	2203-006562	SA
C505	C-CER,CHIP	2203-005050	SA
C511	C-CER,CHIP	2203-005395	SA
C513	C-CER,CHIP	2203-005482	SA
C514	C-CER,CHIP	2203-006841	SA
C515	C-CER,CHIP	2203-006260	SA
C516	C-CER,CHIP	2203-006562	SA

Design LOC	Description	SEC Code	STATUS
C517	C-CER,CHIP	2203-000330	SA
C519	C-CER,CHIP	2203-005482	SA
C521	C-CER,CHIP	2203-005395	SA
C523	C-CER,CHIP	2203-005395	SA
C524	C-CER,CHIP	2203-005482	SA
C525	C-CER,CHIP	2203-000330	SA
C526	C-CER,CHIP	2203-005482	SA
C527	C-CER,CHIP	2203-005395	SA
C540	C-CER,CHIP	2203-000278	SA
C544	C-CER,CHIP	2203-000278	SA
C550	C-CER,CHIP	2203-000233	SA
C551	C-CER,CHIP	2203-000233	SA
C552	C-CER,CHIP	2203-000233	SA
C553	C-CER,CHIP	2203-005482	SA
C600	C-CER,CHIP	2203-005482	SA
C601	C-CER,CHIP	2203-005482	SA
C603	C-CER,CHIP	2203-006824	SA
C604	C-CER,CHIP	2203-006562	SA
C613	C-CER,CHIP	2203-005482	SA
C615	C-CER,CHIP	2203-005482	SA
C616	C-CER,CHIP	2203-006824	SA
C620	C-CER,CHIP	2203-005993	SA
C622	C-CER,CHIP	2203-005993	SA
C633	C-CER,CHIP	2203-005482	SA
C634	C-CER,CHIP	2203-006137	SA
C635	C-CER,CHIP	2203-006137	SA
C636	C-CER,CHIP	2203-005482	SA
C637	C-CER,CHIP	2203-000386	SA
C638	C-CER,CHIP	2203-000386	SA
C639	C-CER,CHIP	2203-006260	SA
C640	C-CER,CHIP	2203-006260	SA
C702	C-CER,CHIP	2203-002443	SA
C703	C-CER,CHIP	2203-006841	SA
C704	C-CER,CHIP	2203-005061	SA
C705	C-CER,CHIP	2203-005482	SA

Design LOC	Description	SEC Code	STATUS
C713	C-CER,CHIP	2203-006562	SA
C736	C-CER,CHIP	2203-006562	SA
C737	C-CER,CHIP	2203-000812	SA
D500	DIODE-TVS	0406-001254	SA
D501	DIODE-TVS	0406-001254	SA
D502	DIODE-TVS	0406-001190	SA
DUF100	FILTER-LC	2909-001279	SA
F100	DUPLEXER-FEM	2911-000084	SA
F500	FILTER-EMI/ESD	2901-001376	SA
F702	FILTER-EMI SMD	2901-001404	SA
F703	FILTER-EMI SMD	2901-001404	SA
F704	FILTER-EMI SMD	2901-001404	SA
F705	FILTER-EMI SMD	2901-001404	SA
F706	FILTER-EMI SMD	2901-001404	SA
HDC700	HEADER-BOARD TO BOARD	3711-006326	SA
IFC500	SOCKET-INTERFACE	3710-002499	SA
L100	INDUCTOR-SMD	2703-002314	SA
L101	INDUCTOR-SMD	2703-001708	SA
L102	C-CER,CHIP	2203-005234	SA
L103	C-CER,CHIP	2203-005234	SA
L104	INDUCTOR-SMD	2703-002558	SA
L105	C-CER,CHIP	2203-005281	SA
L106	C-CER,CHIP	2203-005281	SA
L107	INDUCTOR-SMD	2703-002558	SA
L108	C-CER,CHIP	2203-005281	SA
L109	INDUCTOR-SMD	2703-002608	SA
L110	C-CER,CHIP	2203-005281	SA
L112	C-CER,CHIP	2203-005234	SA
L113	INDUCTOR-SMD	2703-001748	SA
L114	C-CER,CHIP	2203-005234	SA
L117	C-CER,CHIP	2203-005393	SA
L119	BEAD-SMD	3301-001659	SA
L121	C-CER,CHIP	2203-001017	SA
L300	BEAD-SMD	3301-001729	SA
L401	INDUCTOR-SMD	2703-003113	SA

Design LOC	Description	SEC Code	STATUS
L500	BEAD-SMD	3301-001729	SA
L501	BEAD-SMD	3301-001729	SA
L503	BEAD-SMD	3301-001729	SA
L505	BEAD-SMD	3301-001729	SA
L506	BEAD-SMD	3301-001729	SA
L507	BEAD-SMD	3301-001729	SA
L508	BEAD-SMD	3301-001729	SA
L600	BEAD-SMD	3301-001729	SA
L601	BEAD-SMD	3301-001729	SA
L700	BEAD-SMD	3301-001729	SA
OSC100	CRYSTAL-SMD	2801-004587	SA
OSC300	CRYSTAL-SMD	2801-004543	SA
OSC301	CRYSTAL-SMD	2801-004466	SA
OSC400	CRYSTAL-SMD	2801-004466	SA
PAM100	IC-POWER AMP	1201-002423	SA
R100	C-CER,CHIP	2203-005057	SA
R103	R-CHIP	2007-008419	SA
R105	R-CHIP	2007-001313	SA
R107	R-CHIP	2007-000143	SA
R111	R-CHIP	2007-000162	SA
R113	R-CHIP	2007-000162	SA
R117	R-CHIP	2007-007489	SA
R200	R-CHIP	2007-000148	SA
R201	R-CHIP	2007-000148	SA
R202	R-CHIP	2007-008516	SA
R203	R-CHIP	2007-007107	SA
R204	R-CHIP	2007-000148	SA
R207	R-CHIP	2007-000758	SA
R213	R-CHIP	2007-009314	SA
R214	R-CHIP	2007-000140	SA
R215	R-CHIP	2007-000148	SA
R217	R-CHIP	2007-001319	SA
R218	R-CHIP	2007-001319	SA
R226	R-CHIP	2007-002796	SA
R227	R-CHIP	2007-000148	SA

Main Electrical Parts List

Design LOC	Description	SEC Code	STATUS
R230	R-CHIP	2007-009314	SA
R231	R-CHIP	2007-000758	SA
R234	R-CHIP	2007-001333	SA
R300	R-CHIP	2007-000157	SA
R301	R-CHIP	2007-000157	SA
R302	R-CHIP	2007-000162	SA
R308	R-CHIP	2007-008050	SA
R309	R-CHIP	2007-008483	SA
R314	R-CHIP	2007-000157	SA
R315	R-CHIP	2007-000162	SA
R326	R-CHIP	2007-000148	SA
R327	R-CHIP	2007-000157	SA
R328	R-CHIP	2007-008419	SA
R345	R-CHIP	2007-000157	SA
R346	R-CHIP	2007-000157	SA
R347	R-CHIP	2007-000157	SA
R350	R-CHIP	2007-000143	SA
R354	R-CHIP	2007-008483	SA
R359	R-CHIP	2007-008055	SA
R361	R-CHIP	2007-000171	SA
R365	R-CHIP	2007-003013	SA
R367	R-CHIP	2007-000162	SA
R368	R-CHIP	2007-000162	SA
R369	R-CHIP	2007-008055	SA
R375	R-CHIP	2007-000162	SA
R400	R-CHIP	2007-007573	SA
R401	R-CHIP	2007-008354	SA
R402	R-CHIP	2007-000171	SA
R404	R-CHIP	2007-000153	SA
R405	R-CHIP	2007-000141	SA
R408	R-CHIP	2007-007107	SA
R409	R-CHIP	2007-000758	SA
R410	R-CHIP	2007-007107	SA
R503	R-CHIP	2007-001333	SA
R509	R-CHIP	2007-001333	SA

Design LOC	Description	SEC Code	STATUS
R514	R-CHIP	2007-007334	SA
R521	R-CHIP	2007-000159	SA
R522	R-CHIP	2007-000159	SA
R523	R-CHIP	2007-000159	SA
R524	R-CHIP	2007-000159	SA
R525	R-CHIP	2007-000159	SA
R527	R-CHIP	2007-000166	SA
R530	R-CHIP	2007-000170	SA
R531	R-CHIP	2007-000170	SA
R533	R-CHIP	2007-000162	SA
R534	R-CHIP	2007-000157	SA
R535	R-CHIP	2007-007142	SA
R539	R-CHIP	2007-000148	SA
R541	R-CHIP	2007-007306	SA
R545	R-CHIP	2007-007318	SA
R547	R-CHIP	2007-007318	SA
R548	R-CHIP	2007-002796	SA
R549	R-CHIP	2007-000148	SA
R550	R-CHIP	2007-007318	SA
R551	R-CHIP	2007-000148	SA
R552	R-CHIP	2007-007318	SA
R553	R-CHIP	2007-002796	SA
R600	R-CHIP	2007-000157	SA
R606	R-CHIP	2007-001292	SA
R607	R-CHIP	2007-001292	SA
R701	R-CHIP	2007-000148	SA
R702	R-CHIP	2007-007312	SA
R706	R-CHIP	2007-001333	SA
R707	R-CHIP	2007-001333	SA
R708	R-CHIP	2007-000157	SA
R709	R-CHIP	2007-000148	SA
R710	R-CHIP	2007-000157	SA
RFS100	CONNECTOR-COAXIAL	3705-001225	SA
RFS101	CONNECTOR-COAXIAL	3705-001358	SA
RFS102	IC-TRANSCIVER	1205-003093	SA

Design LOC	Description	SEC Code	STATUS
SD500	CONNECTOR-CARD EDGE	3709-001453	SA
SLC700	HEADER-BOARD TO BOARD	3711-006569	SA
TA100	C-TA,CHIP	2404-001496	SA
TA200	C-TA,CHIP	2404-001396	SA
TA400	C-TA,CHIP	2404-001381	SA
TA401	C-TA,CHIP	2404-001381	SA
TA500	C-TA,CHIP	2404-001496	SA
TA501	C-TA,CHIP	2404-001424	SA
TA502	C-TA,CHIP	2404-001381	SA
TA600	C-TA,CHIP	2404-001396	SA
TA601	C-TA,CHIP	2404-001377	SA
TA602	C-TA,CHIP	2404-001226	SA
U100	IC-TRANSCEIVER	1205-002942	SA
U101	IC-CMOS LOGIC	0801-003012	SA
U301	IC-CMOS LOGIC	0801-002237	SA
U302	IC-MICROPROCESSOR	0902-002142	SA
U401	IC-POSI.FIXED REG.	1203-003737	SA
U403	IC-POSI.FIXED REG.	1203-003737	SA
U404	IC-POSI.FIXED REG.	1203-003737	SA
U405	IC-MULTI REG.	1203-004339	SA
U406	IC-POWER SUPERVISOR	1203-004382	SA
U410	FET-SILICON	0505-002207	SA
U500	IC-ANALOG SWITCH	1001-001394	SA
U502	IC-ANALOG SWITCH	1001-001401	SA
U503	IC-CMOS LOGIC	0801-003130	SA
U504	FILTER-EMI SMD	2901-001316	SA
U600	IC-AUDIO AMP	1201-002492	SA
U601	IC-CODEC	1205-003214	SA
U700	IC-HALL EFFECT S/W	1009-001020	SA
UCP201	IC-COMM. CONTROLLER	1205-003082	SA
UME301	IC-MCP	1108-000104	SA
VR200	THERMISTOR-NTC	1404-001221	SA
ZD201	DIODE-TVS	0406-001254	SA
ZD400	DIODE-ZENER	0403-001547	SA
ZD402	DIODE-TVS	0406-001254	SA

Design LOC	Description	SEC Code	STATUS
ZD403	DIODE-TVS	0406-001254	SA
ZD503	DIODE-TVS	0406-001215	SA
ZD505	DIODE-TVS	0406-001267	SA
ZD507	DIODE-TVS	0406-001254	SA
ZD508	DIODE-TVS	0406-001267	SA
ZD700	DIODE-TVS	0406-001190	SA
ZD701	DIODE-TVS	0406-001190	SA
ZD702	DIODE-TVS	0406-001254	SA
ZD703	DIODE-TVS	0406-001254	SA
ZD704	DIODE-TVS	0406-001254	SA
ZD705	DIODE-TVS	0406-001267	SA

7. Block Diagrams

7-1. RF Solution Block Diagram

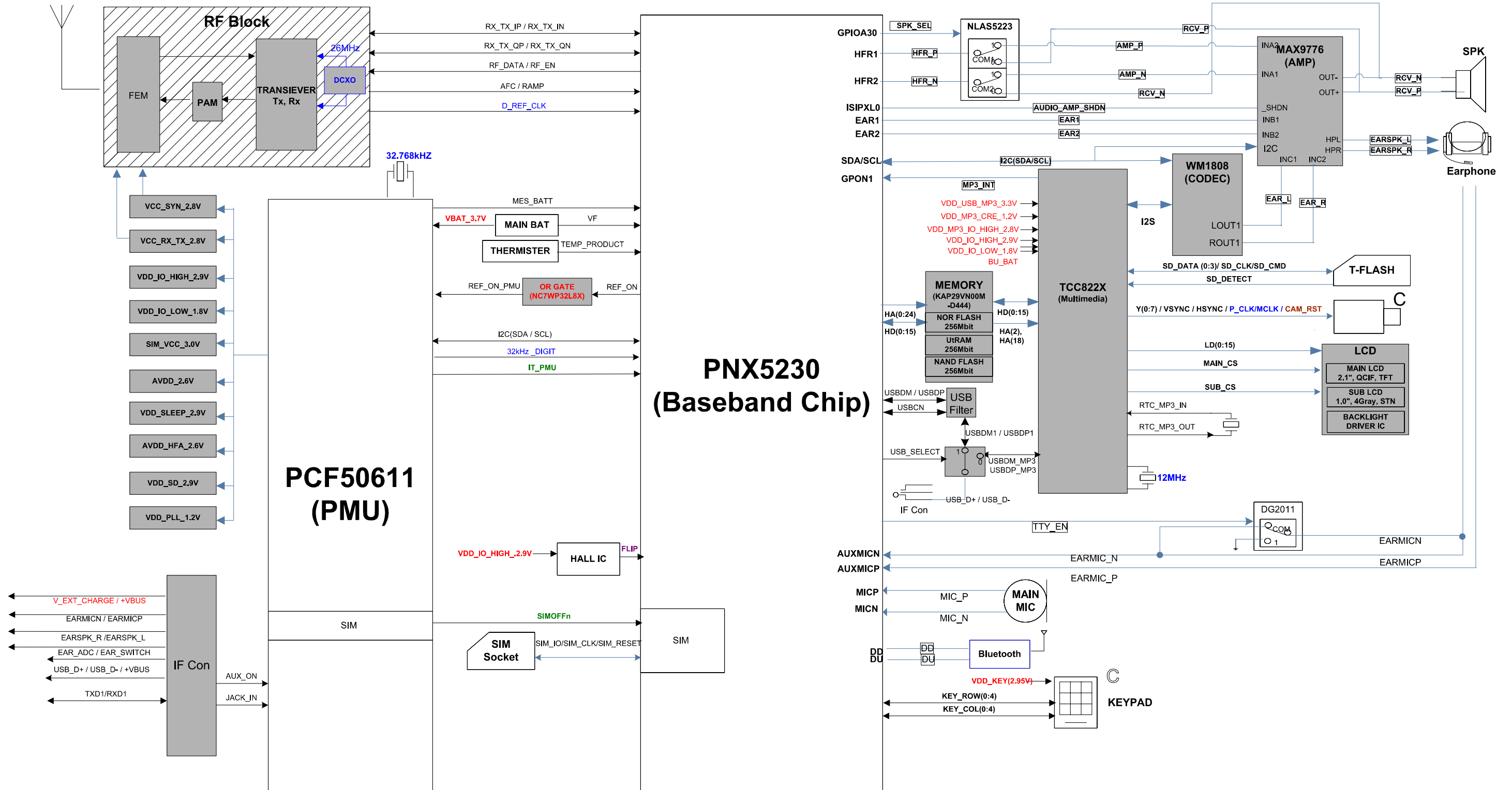

8. PCB Diagrams

Top

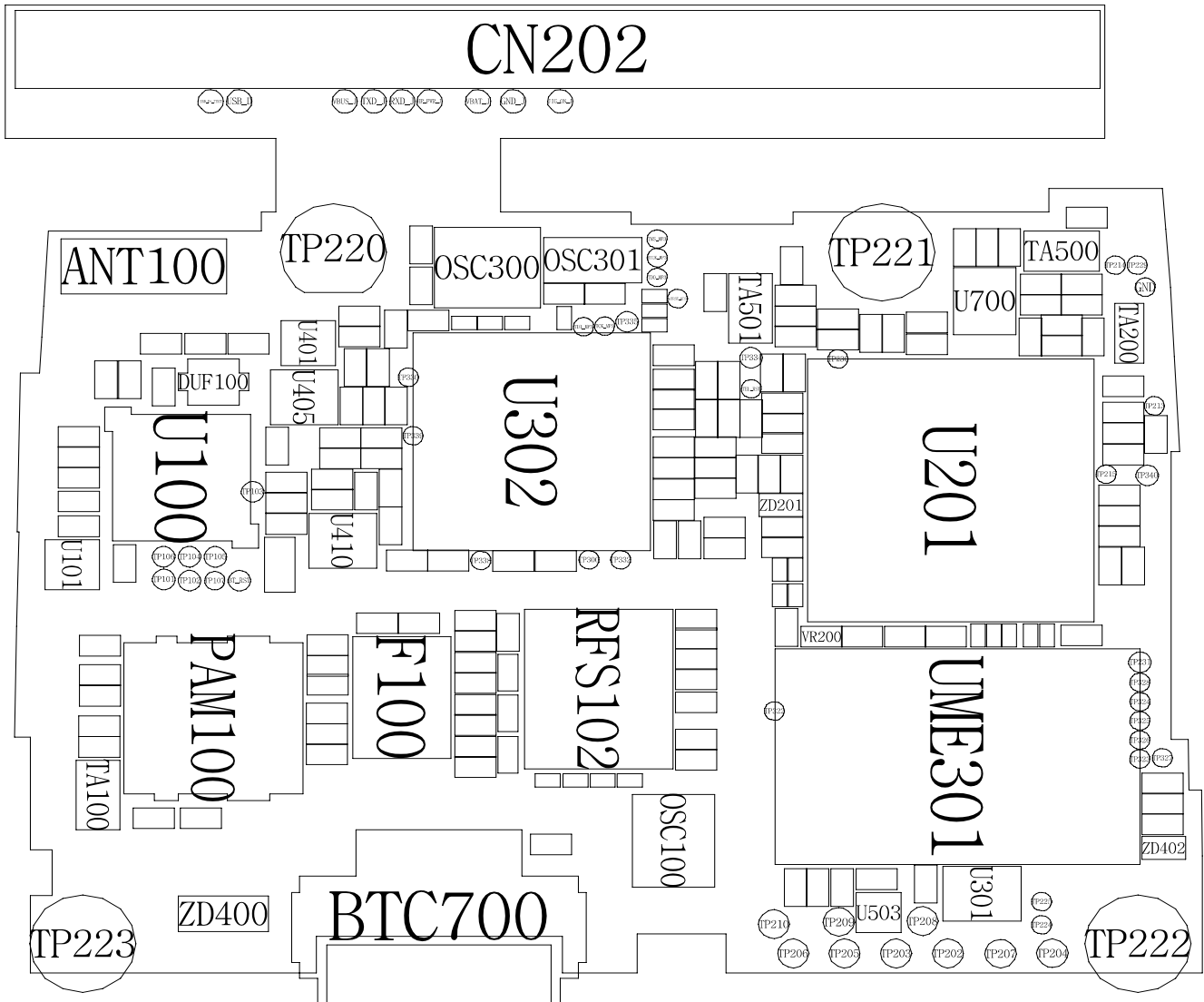

Bottom

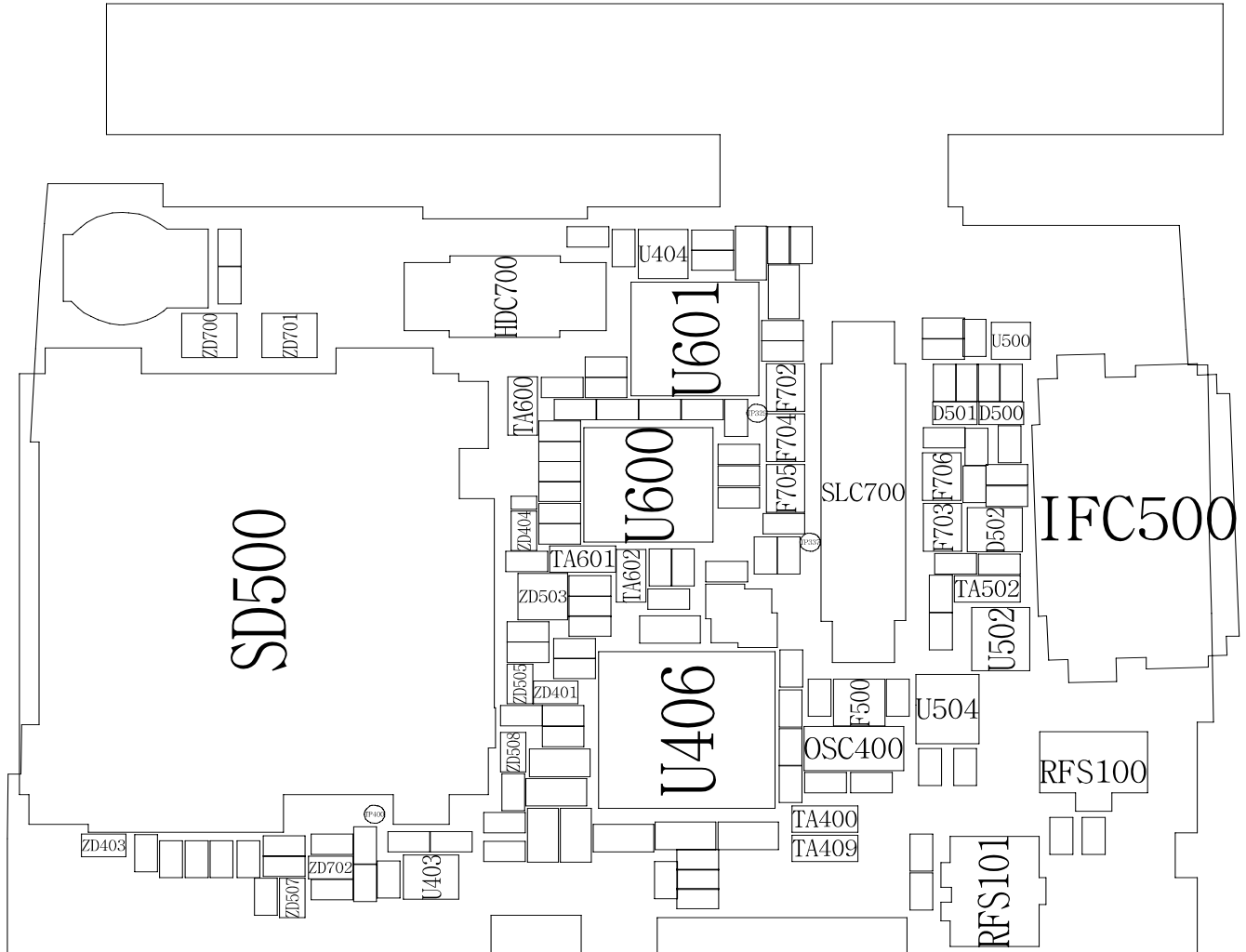

9. Flow Chart of Troubleshooting

9-1. Power On

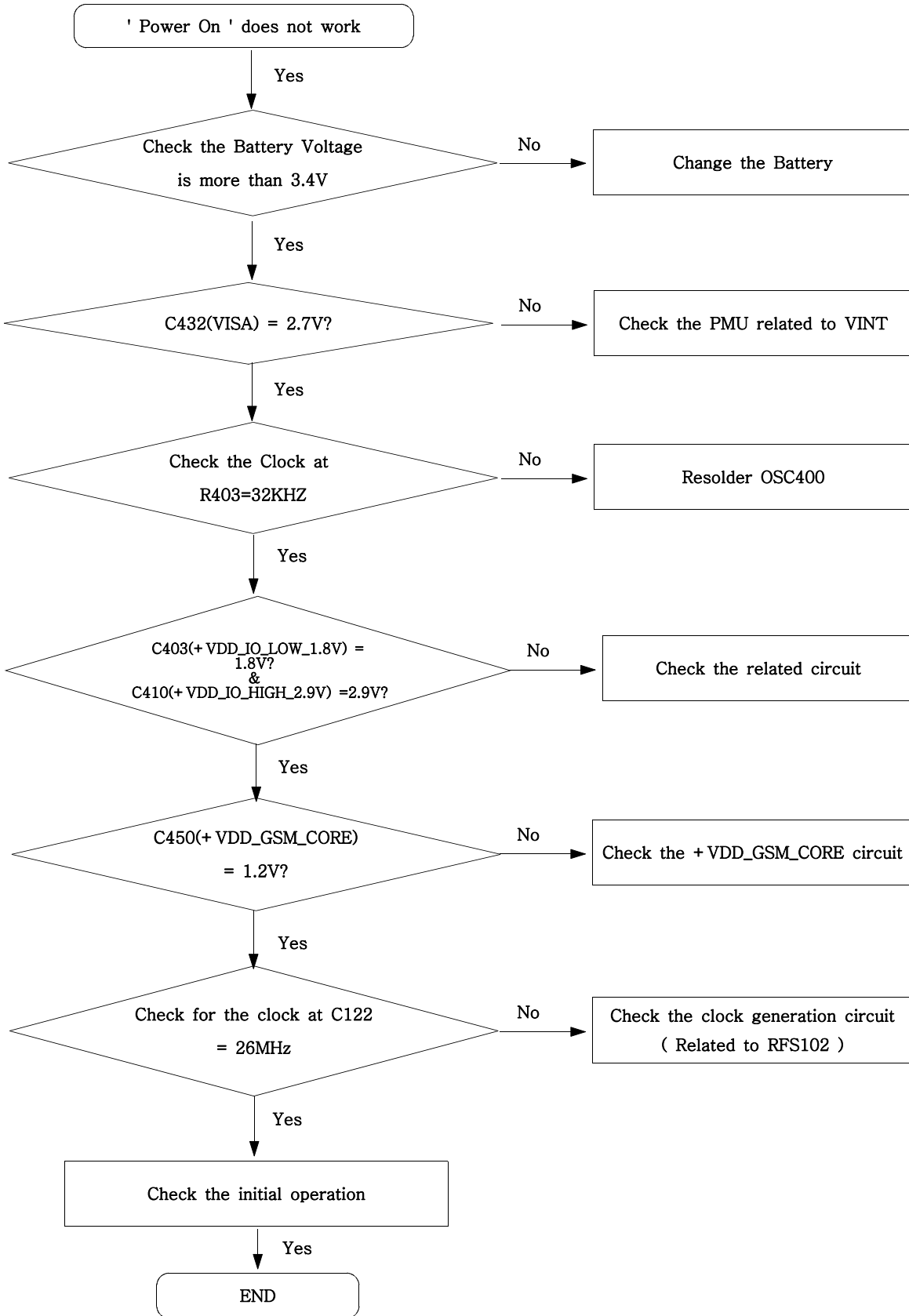

9-2. Initial

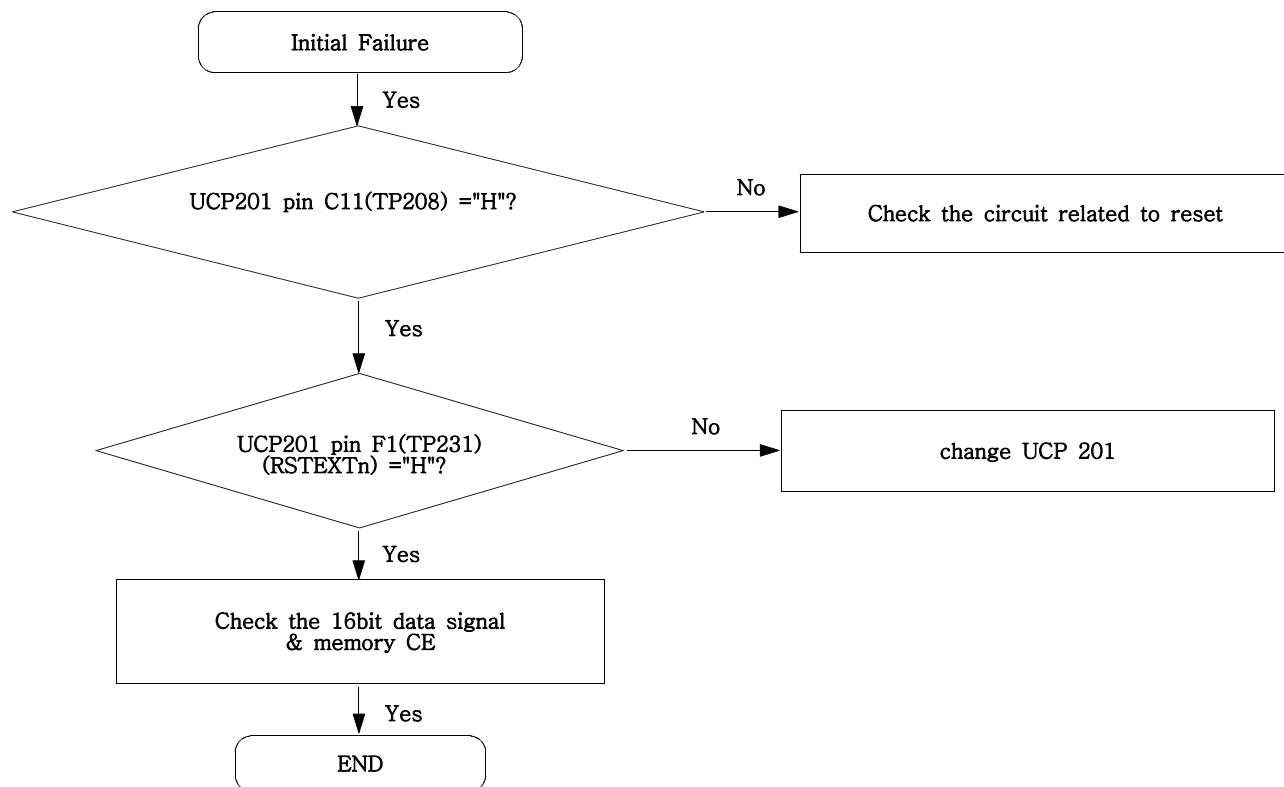

9-3. Charging Part

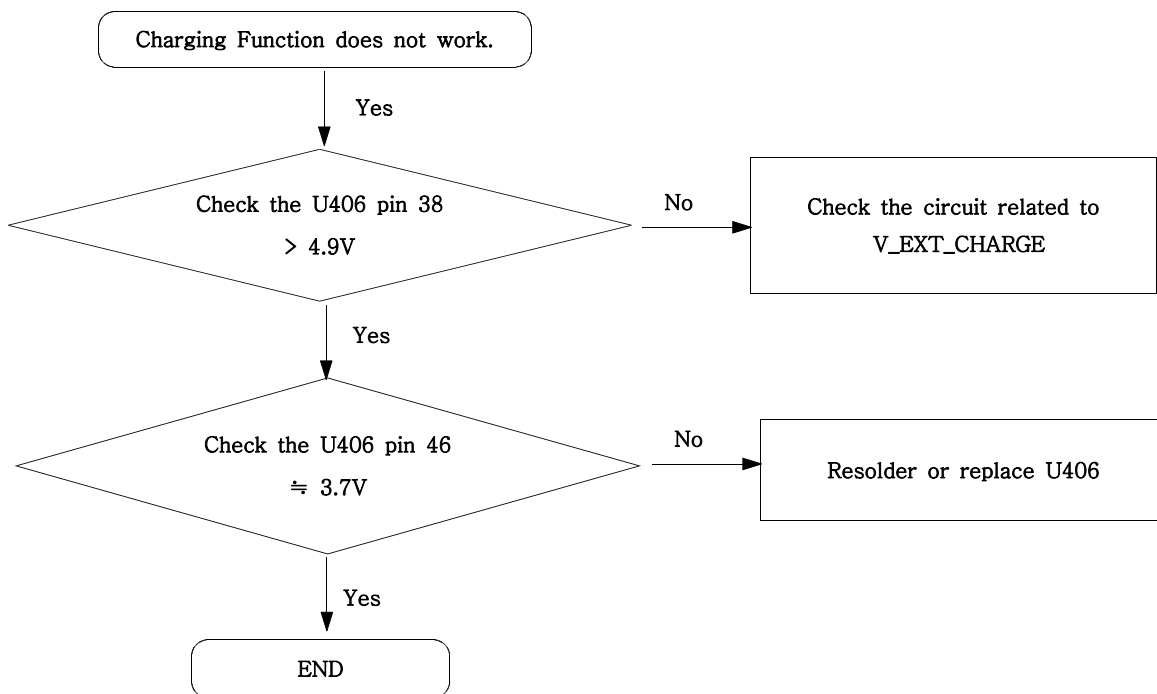

Related Circuit and Block Diagram are same to Power-On Sequence's one.

9-4. Sim Part

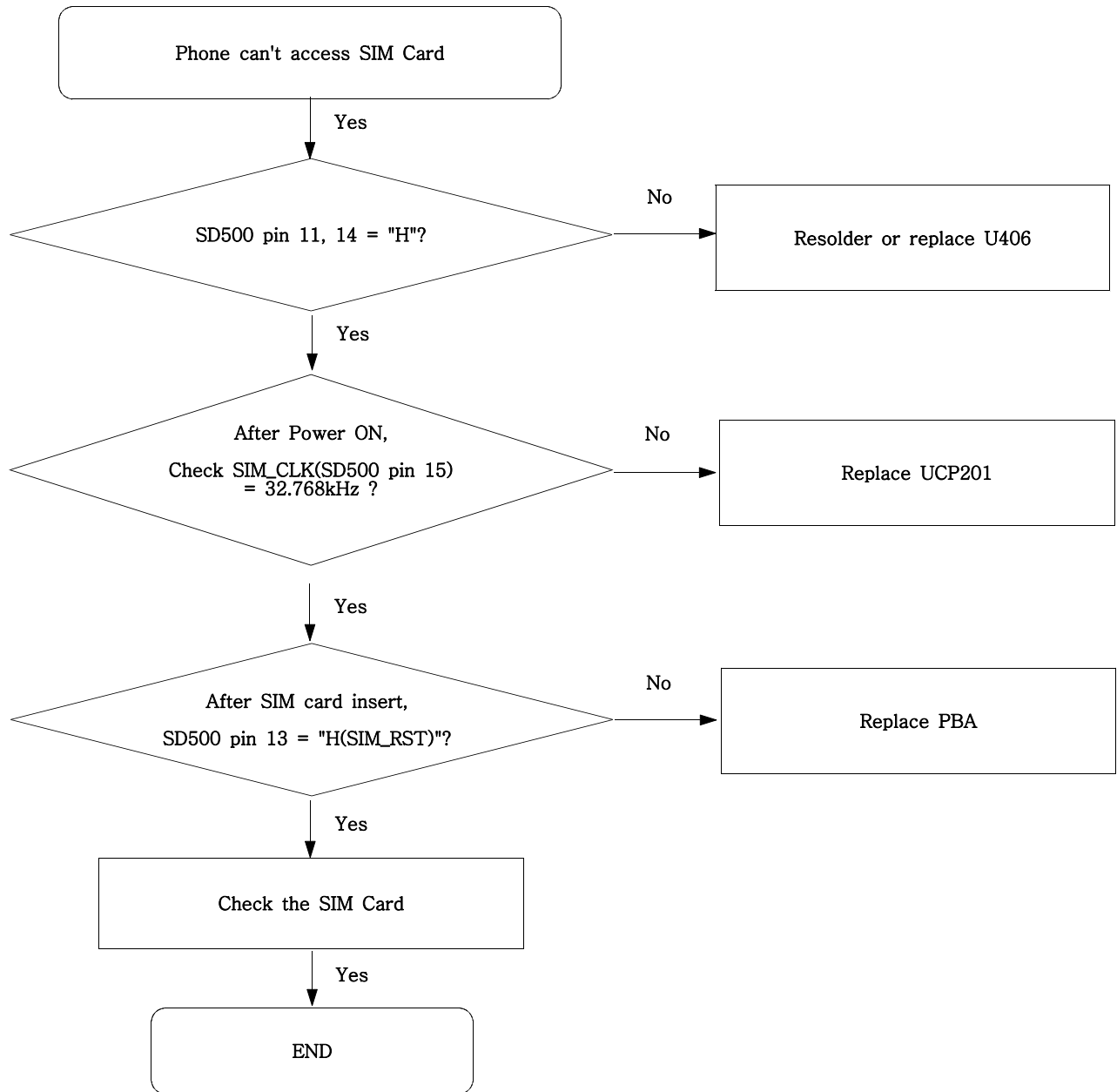

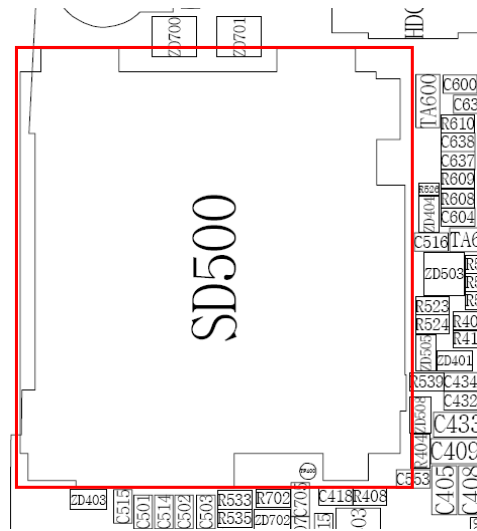
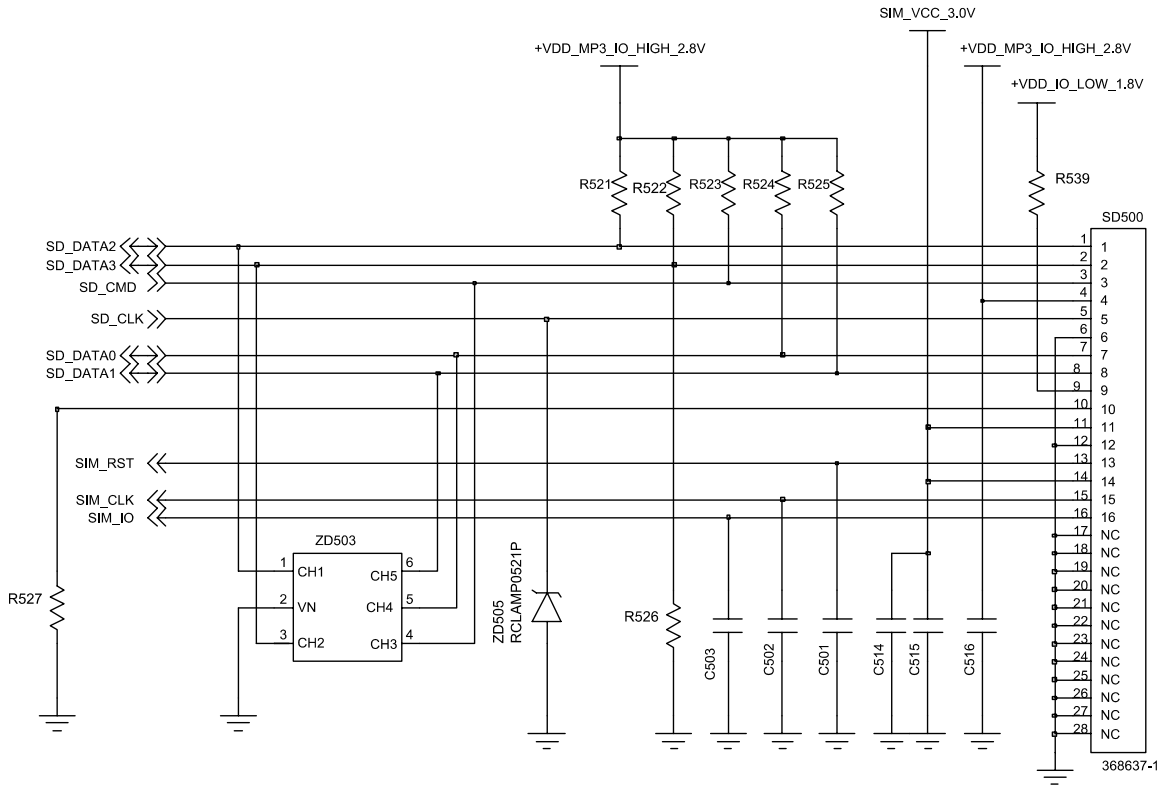

9-5. Microphone Part

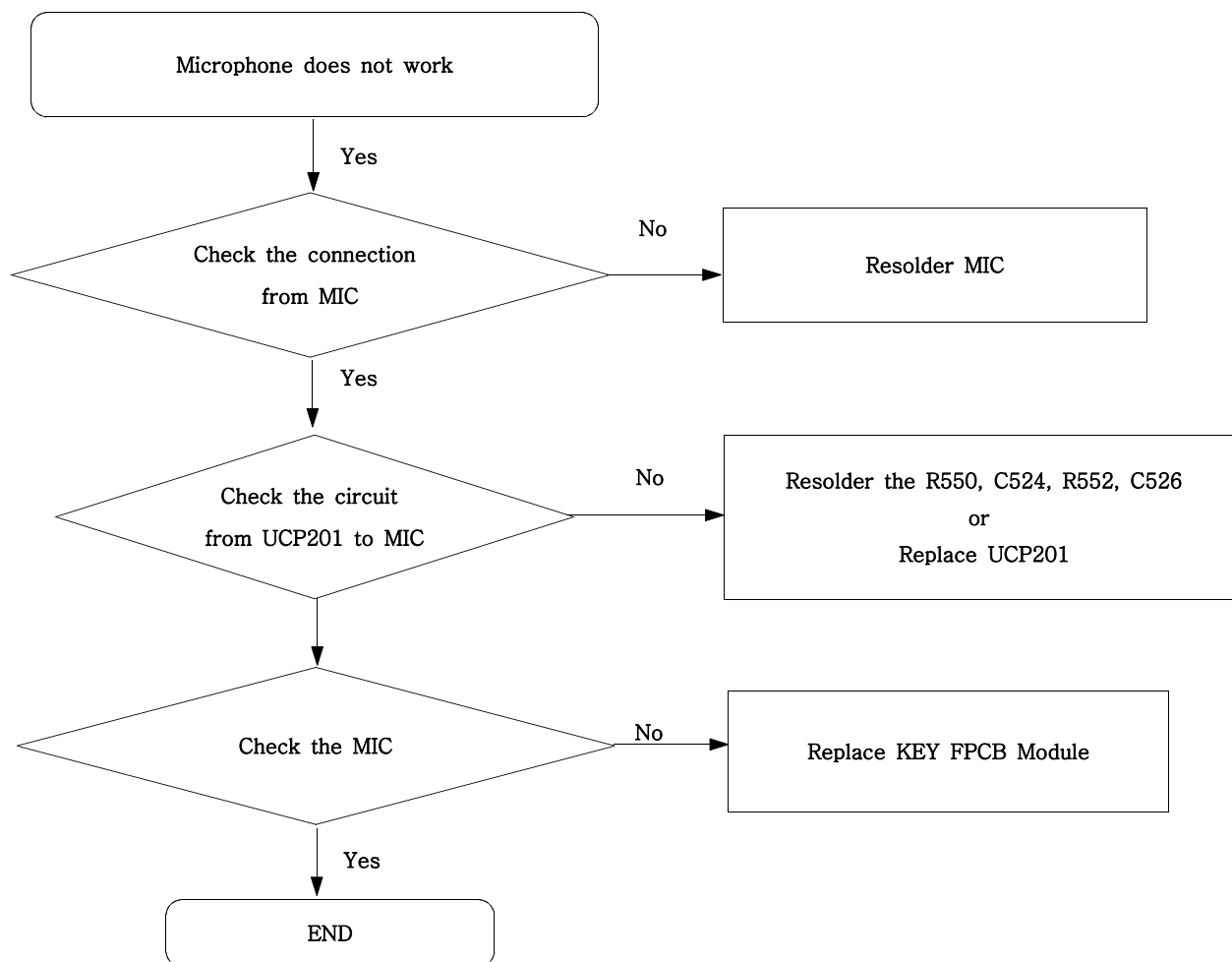

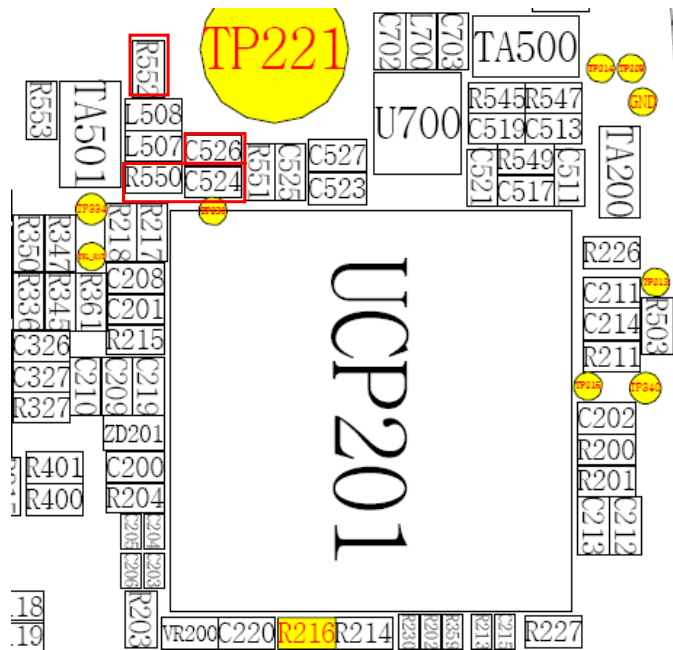
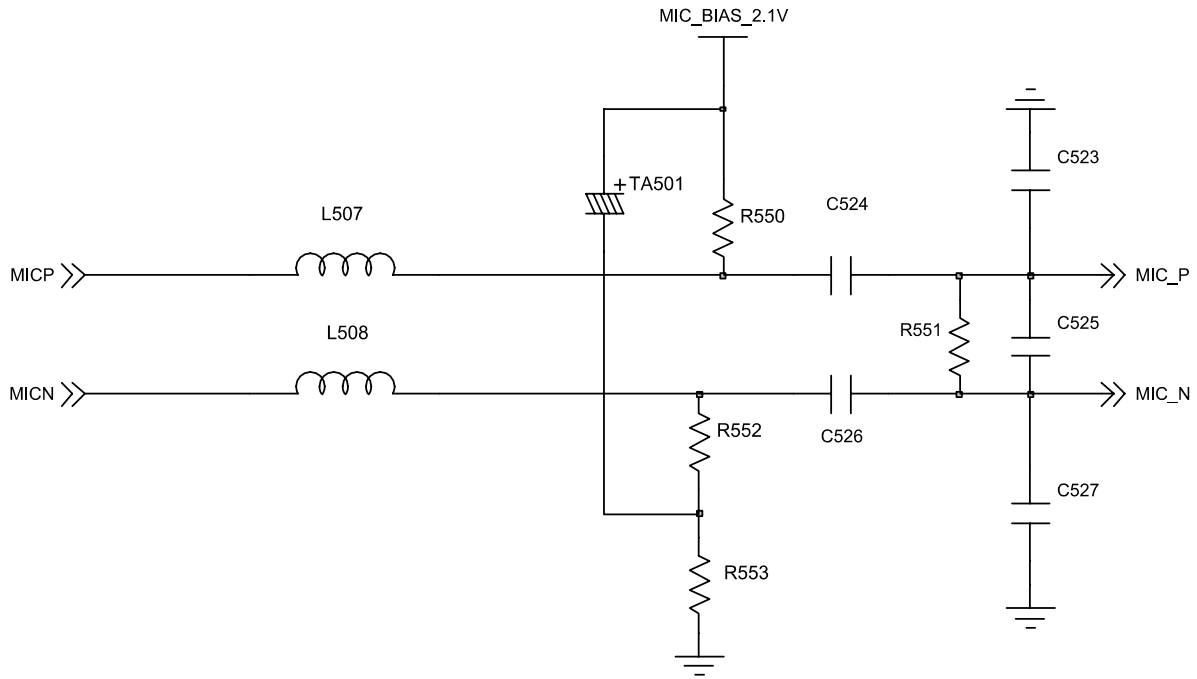

9-6. Speaker Part(Melody)

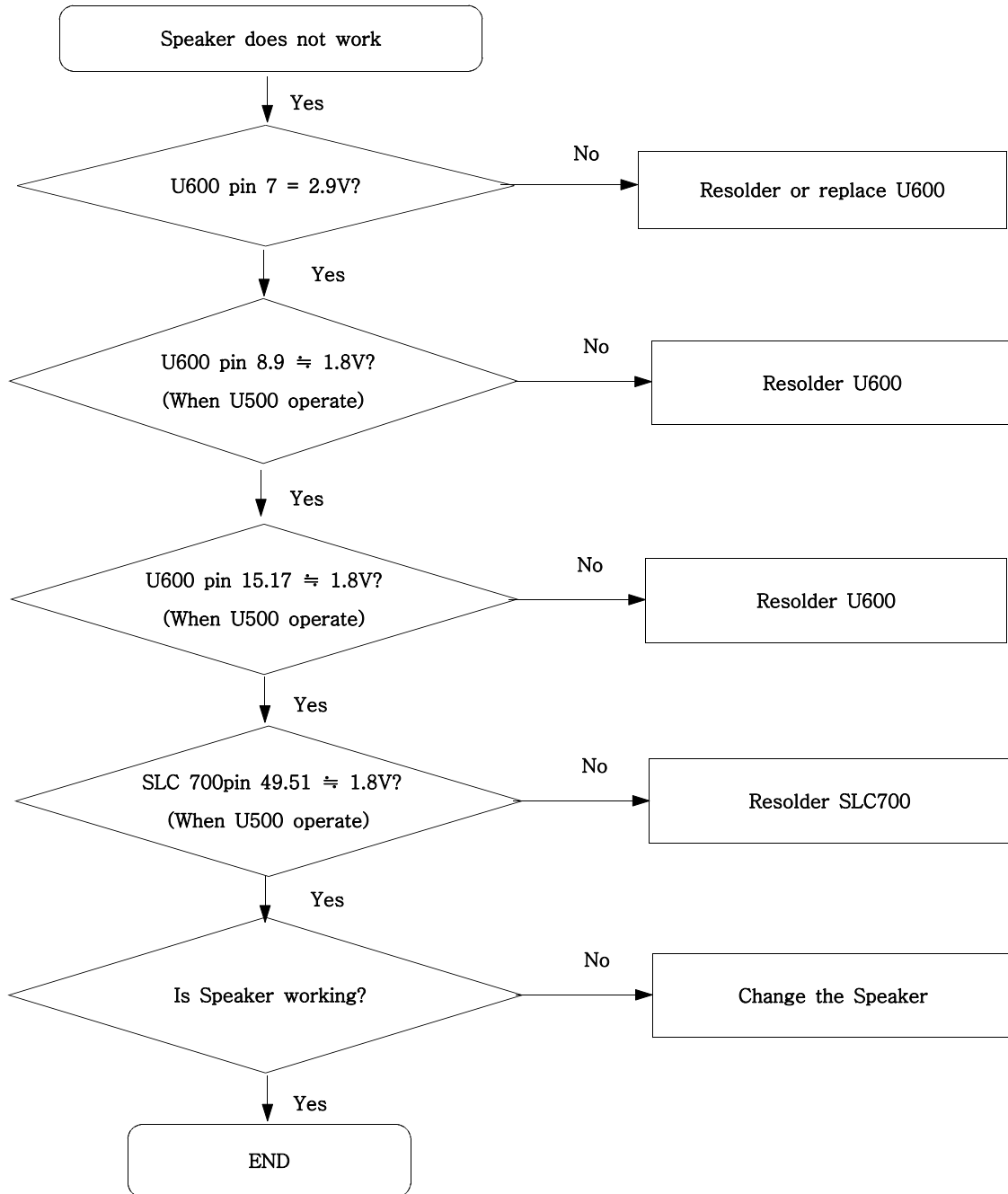

9-7. Receiver Part

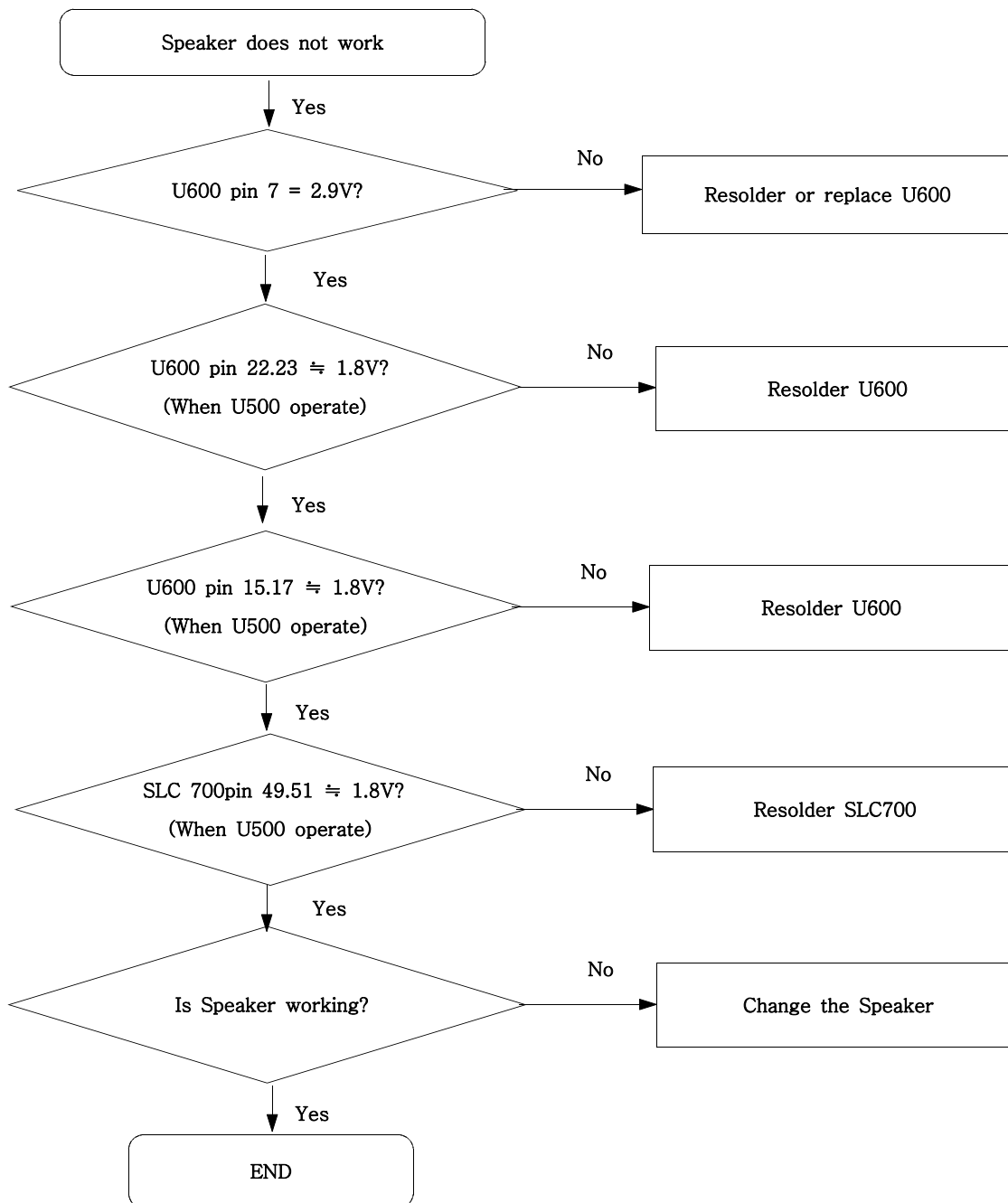

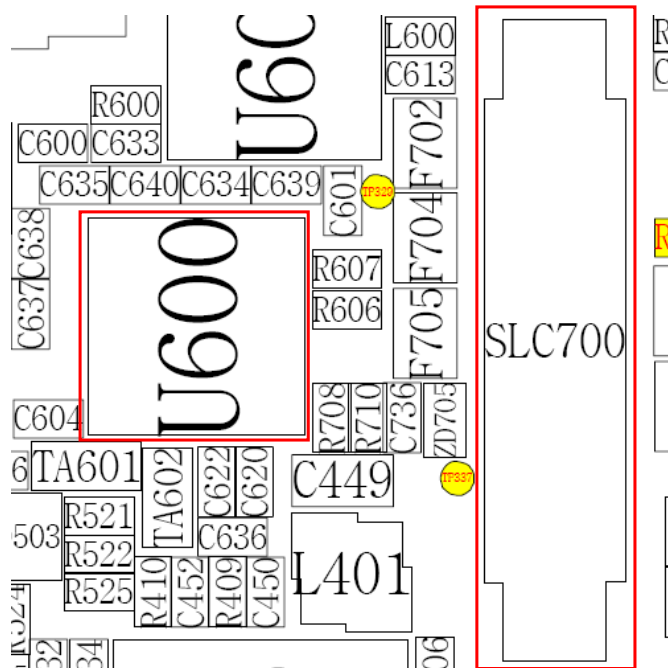
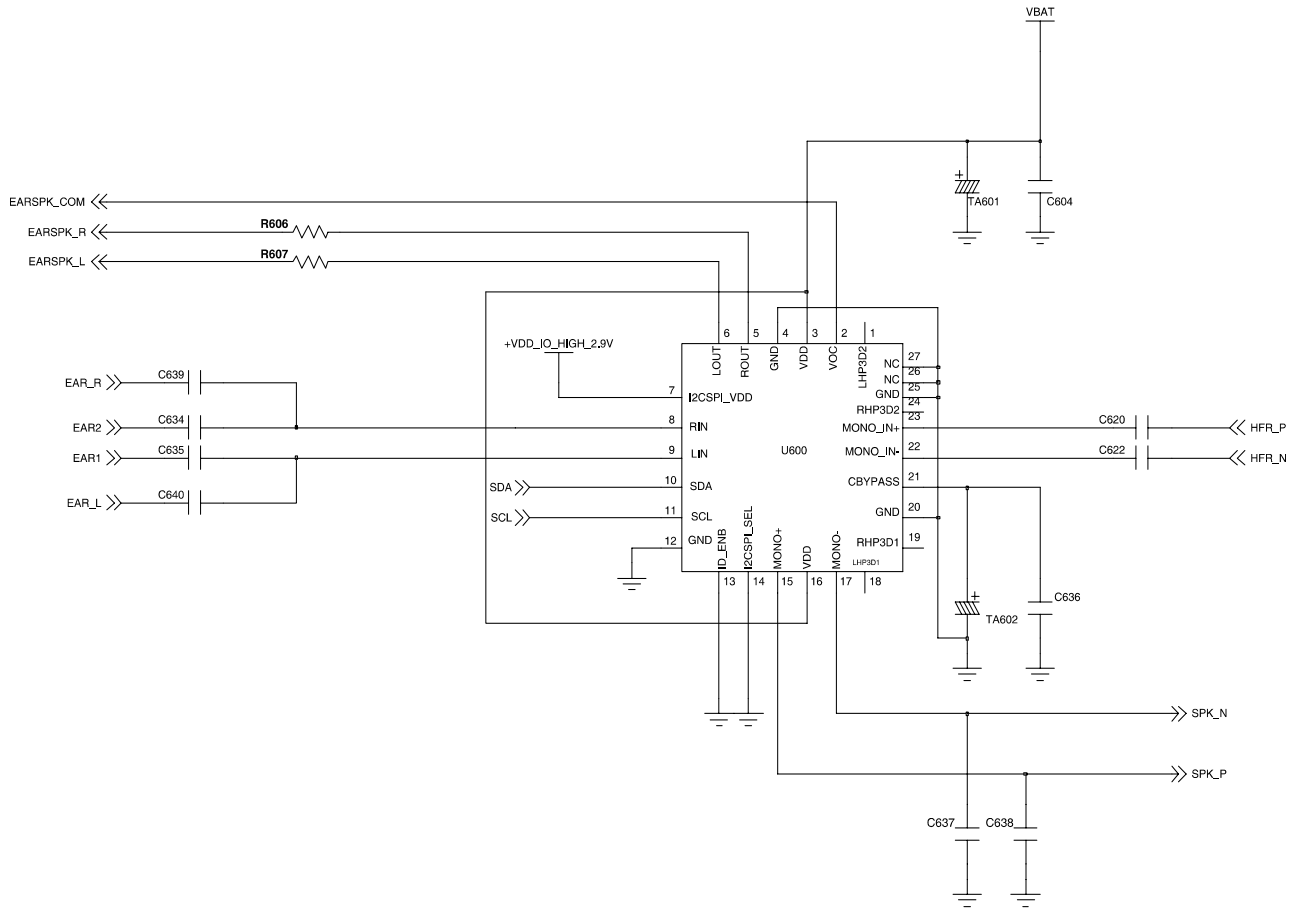

9-8. Key Data Input

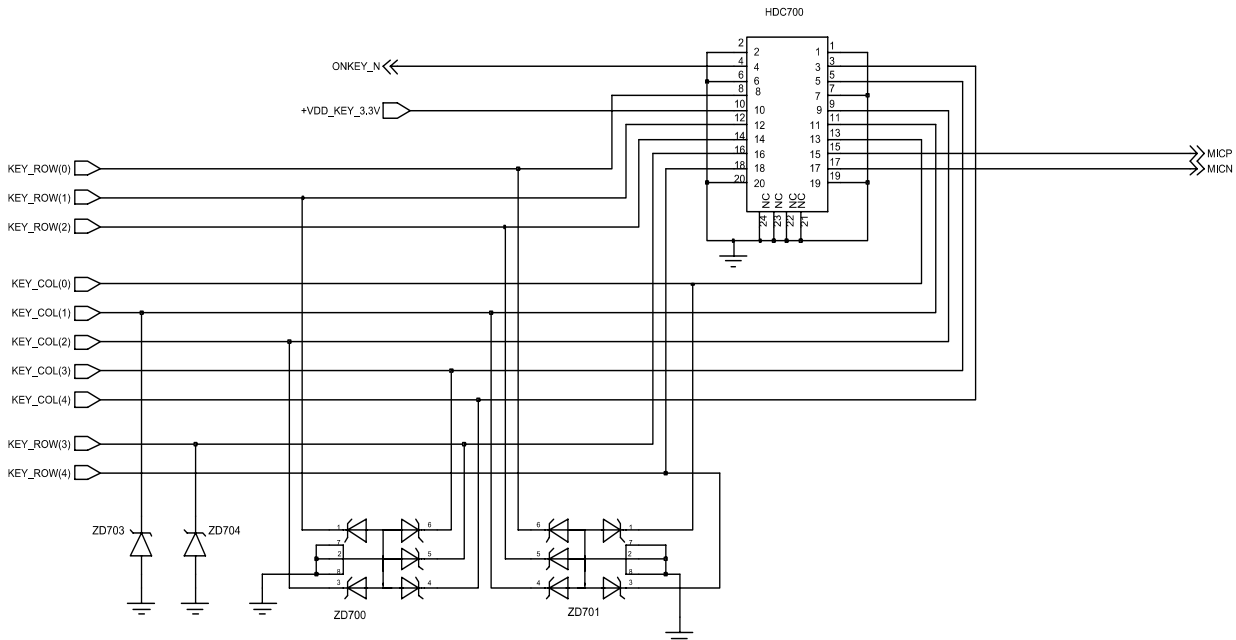
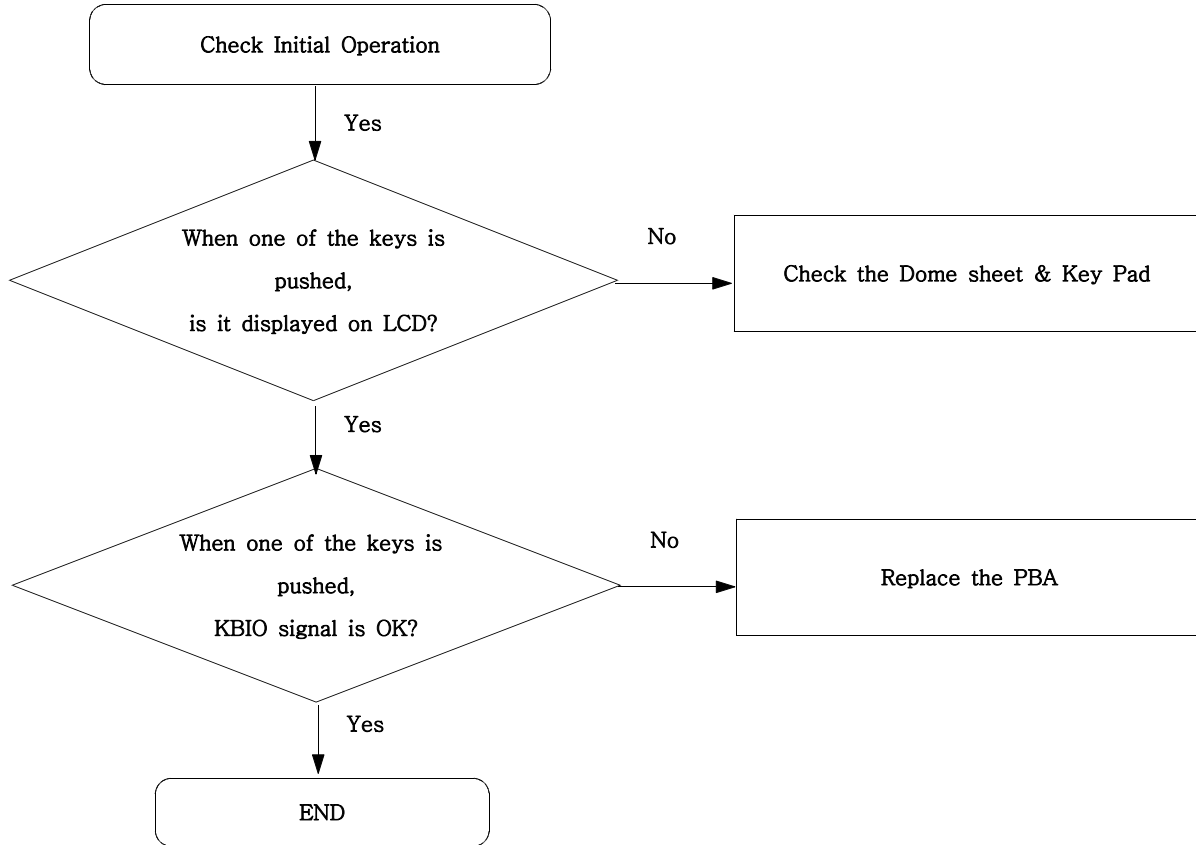

9-9. Back Light (for Color Main LCD)

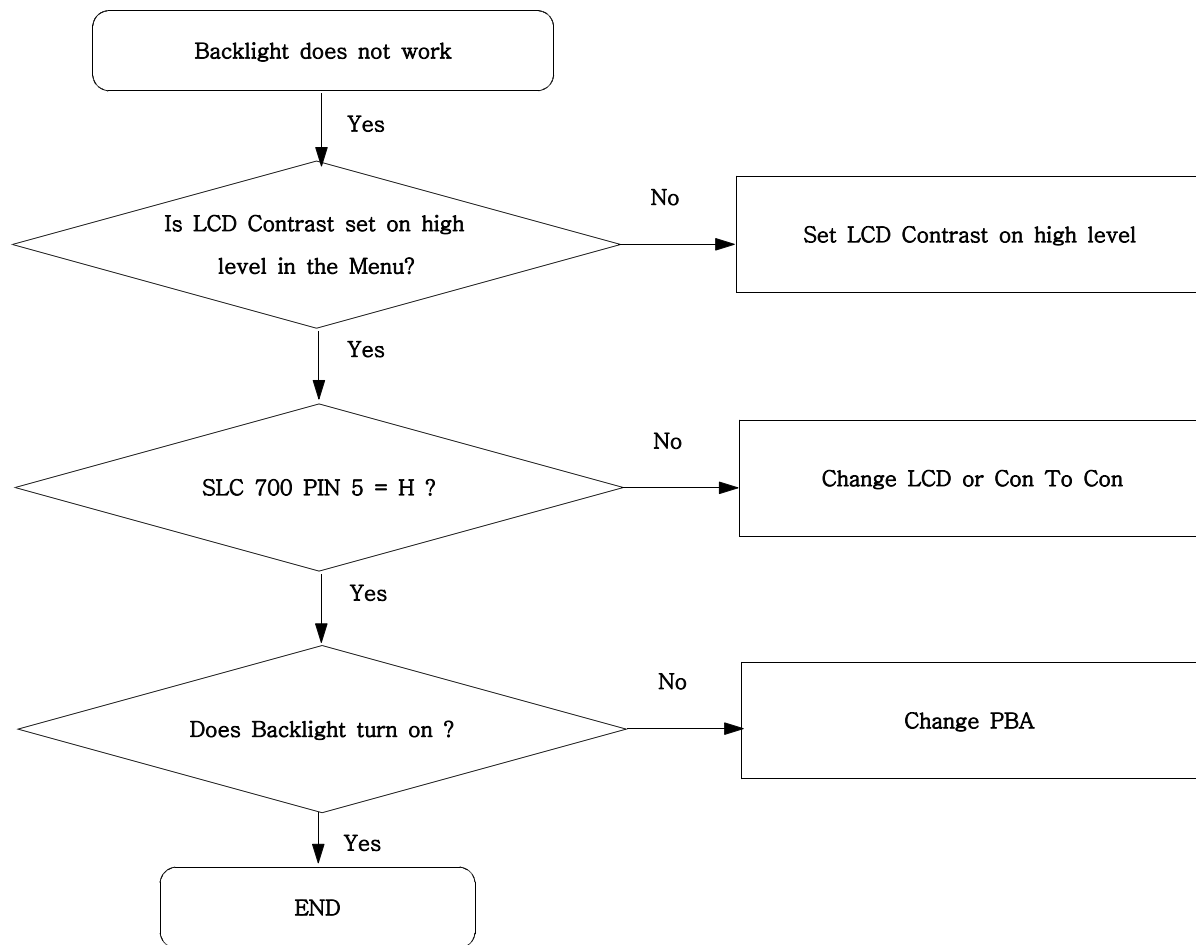

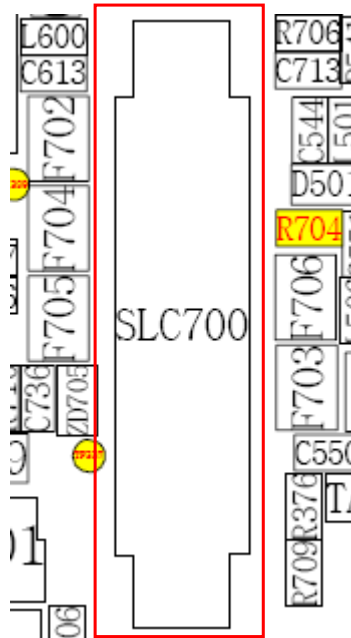
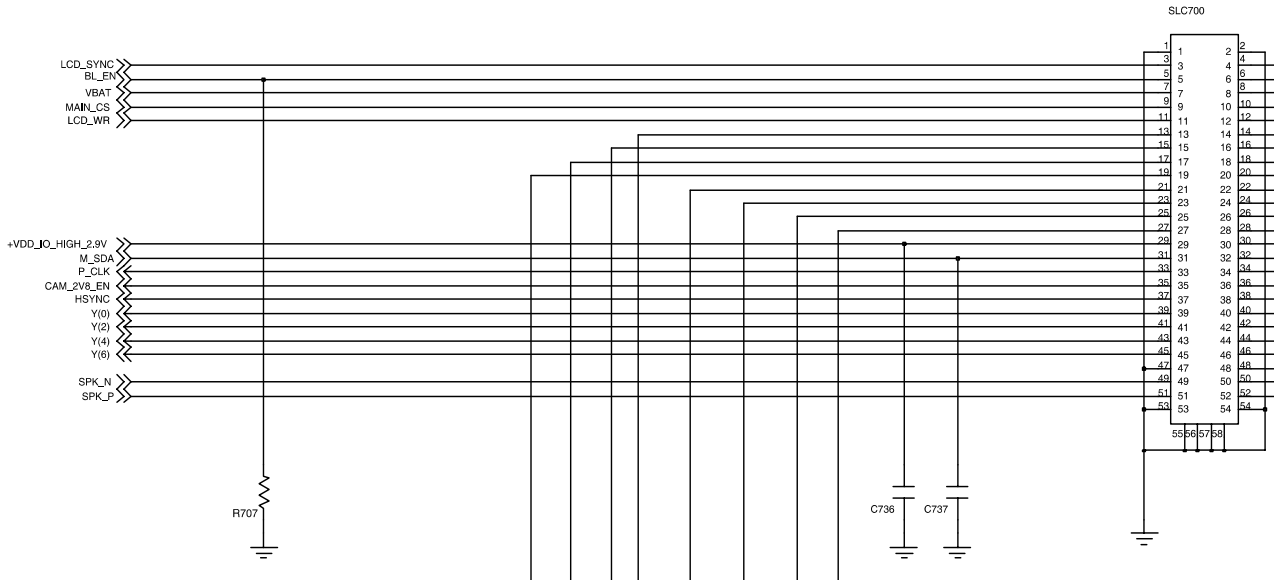

9-11. Camera part

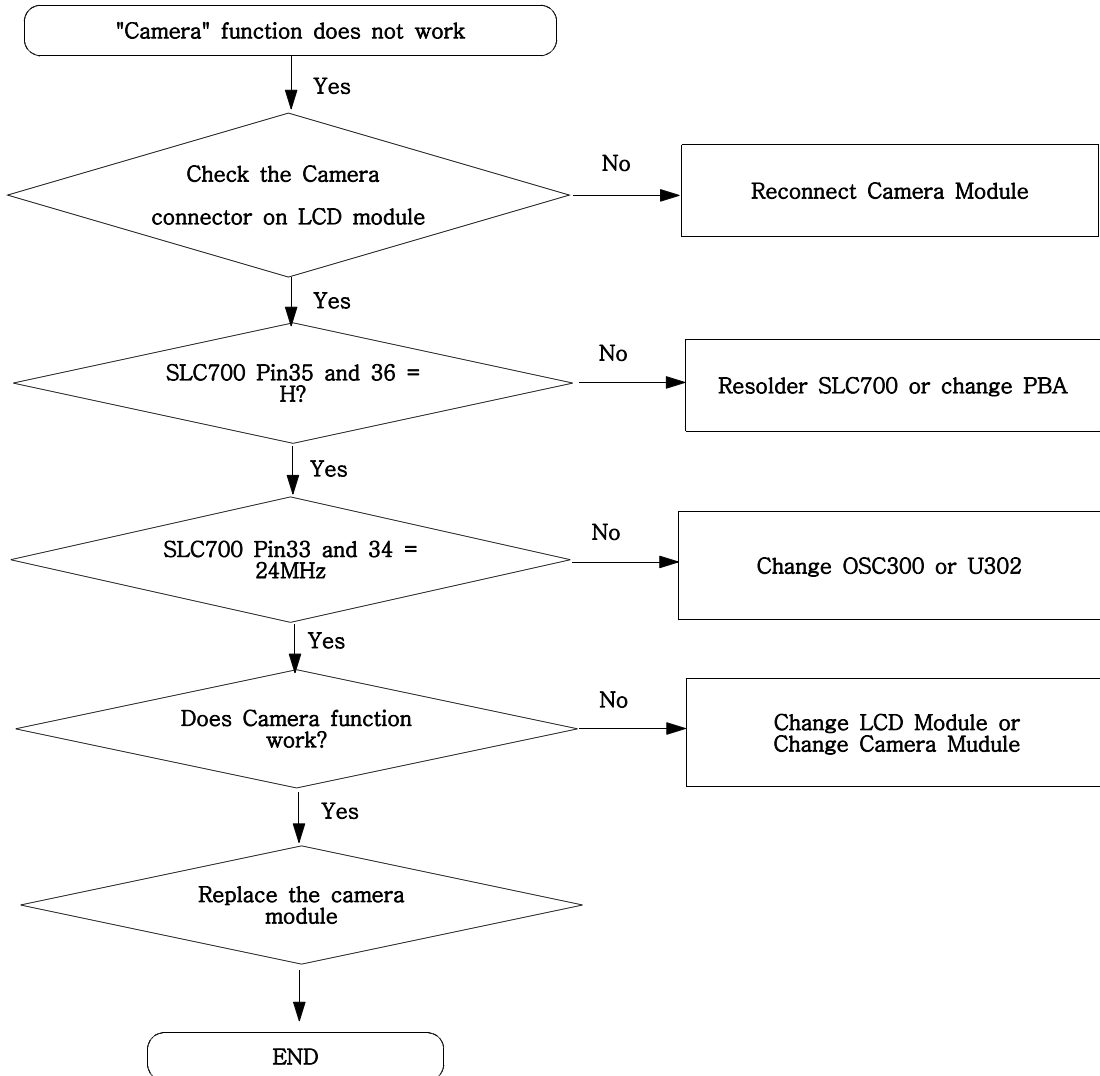

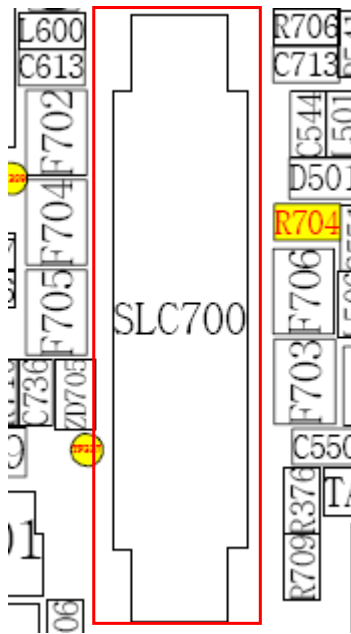
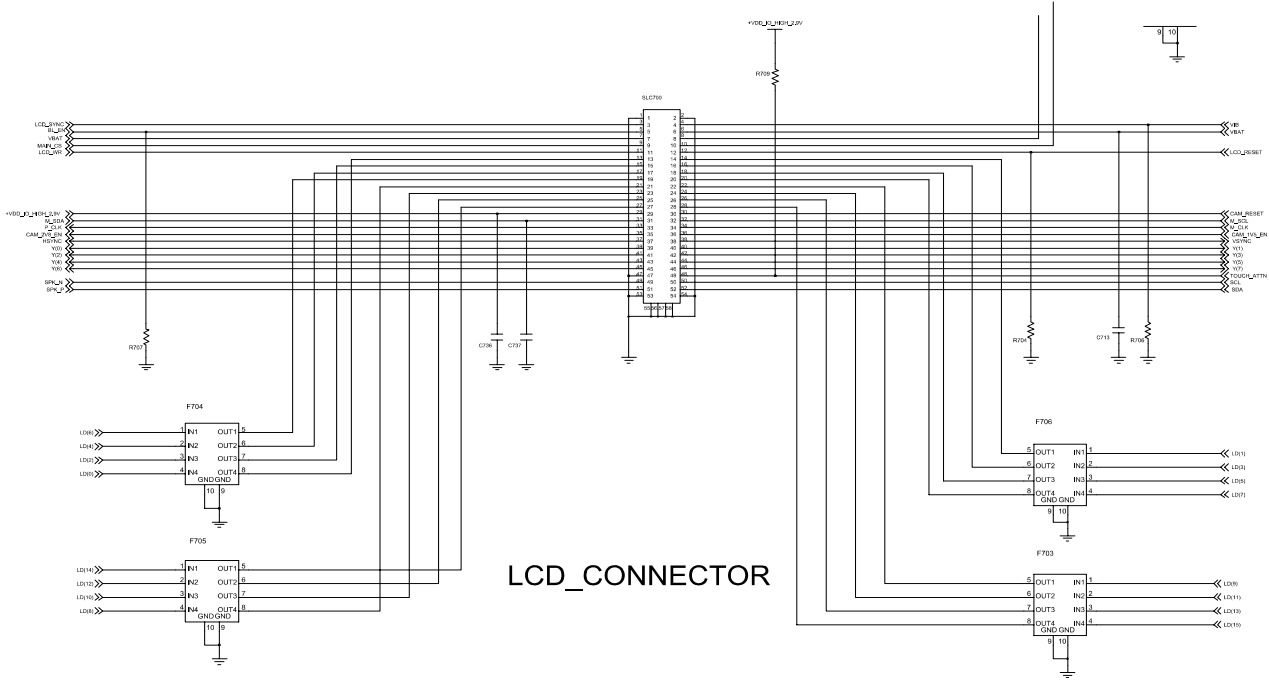

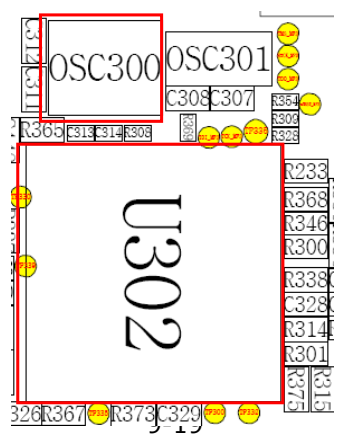
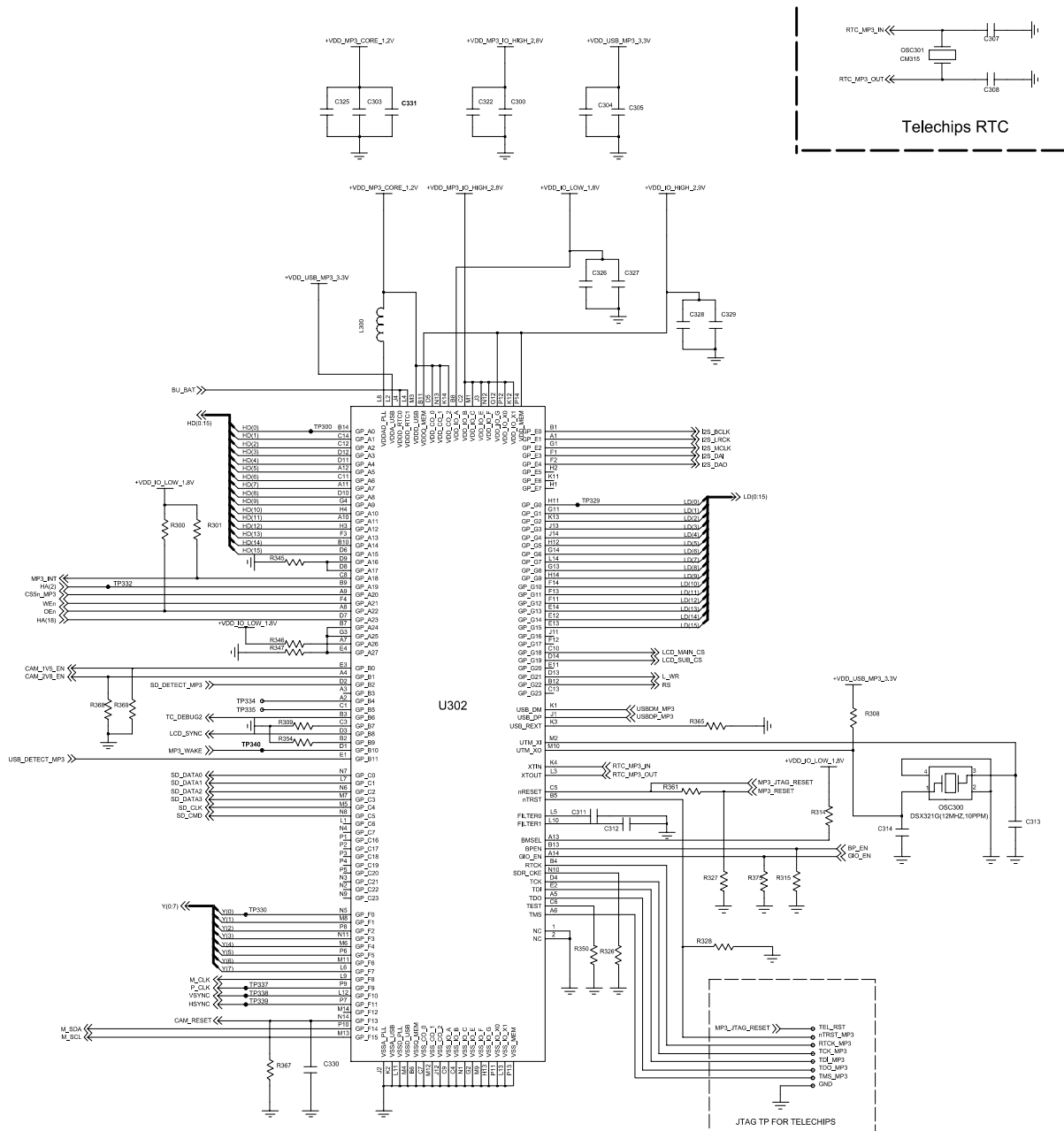

9-12. GSM850 Receiver

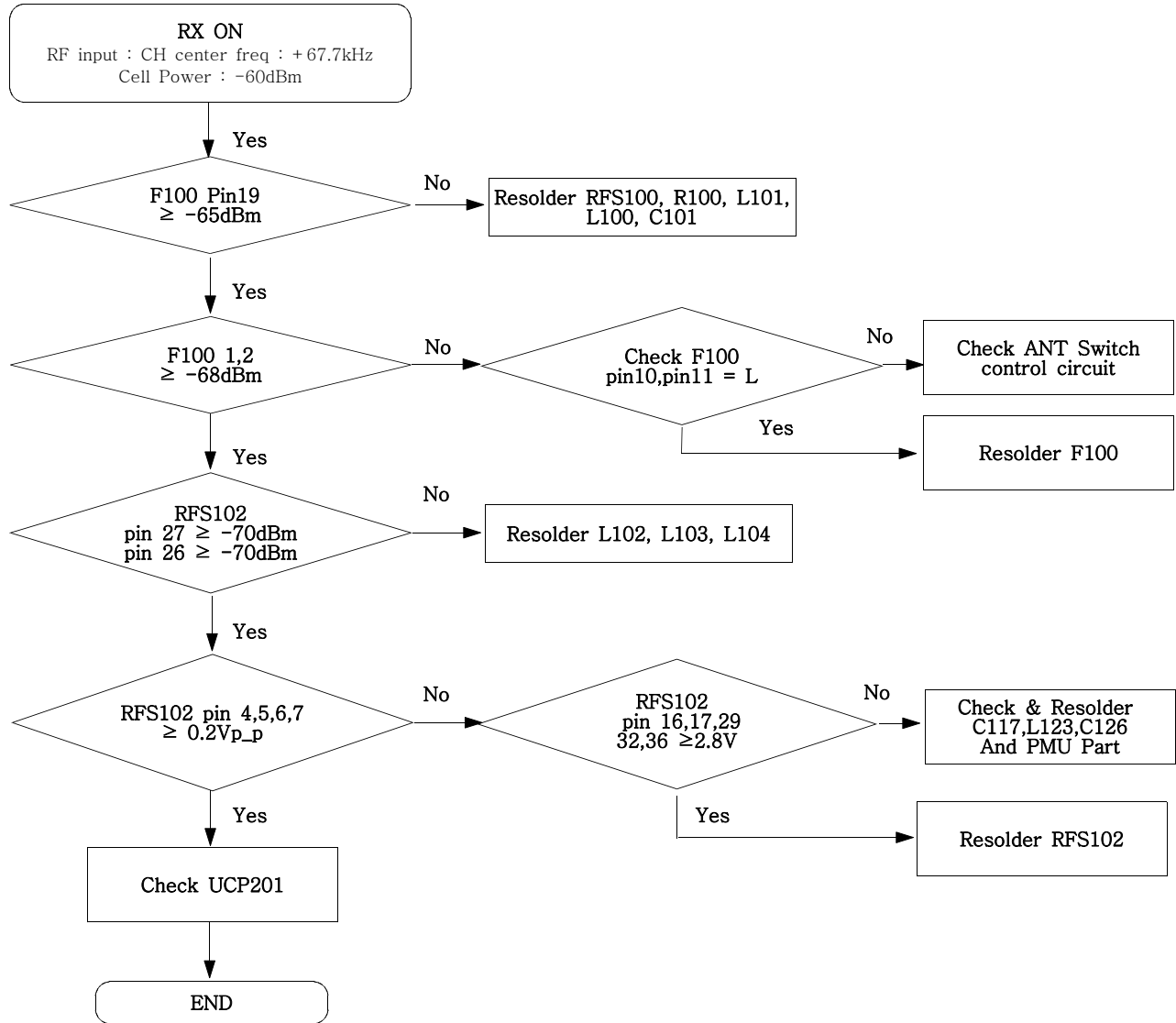

9-13. GSM850 Transmitter

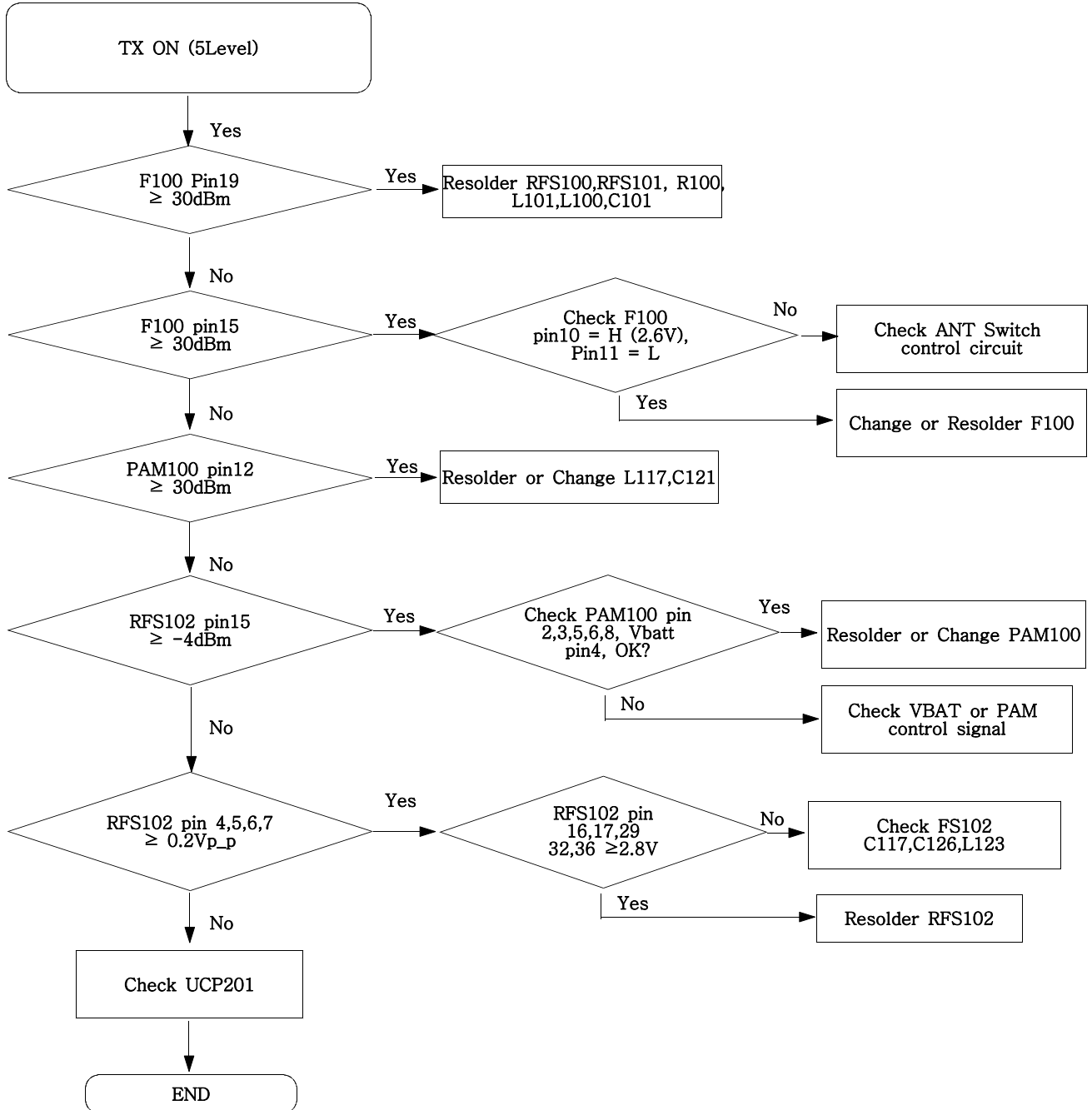

9-14. GSM900 Receiver

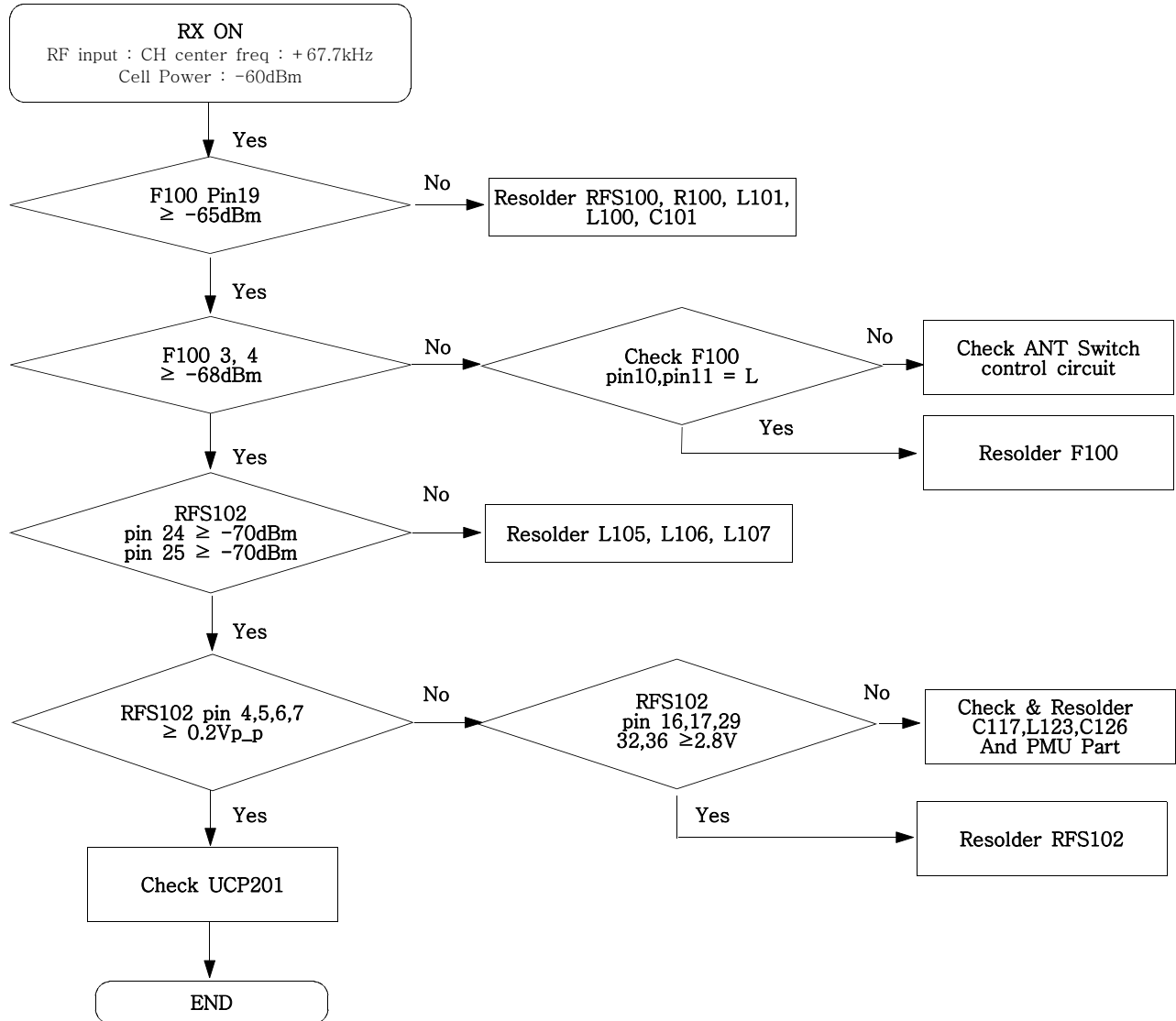

9-15. GSM900 Transmitter

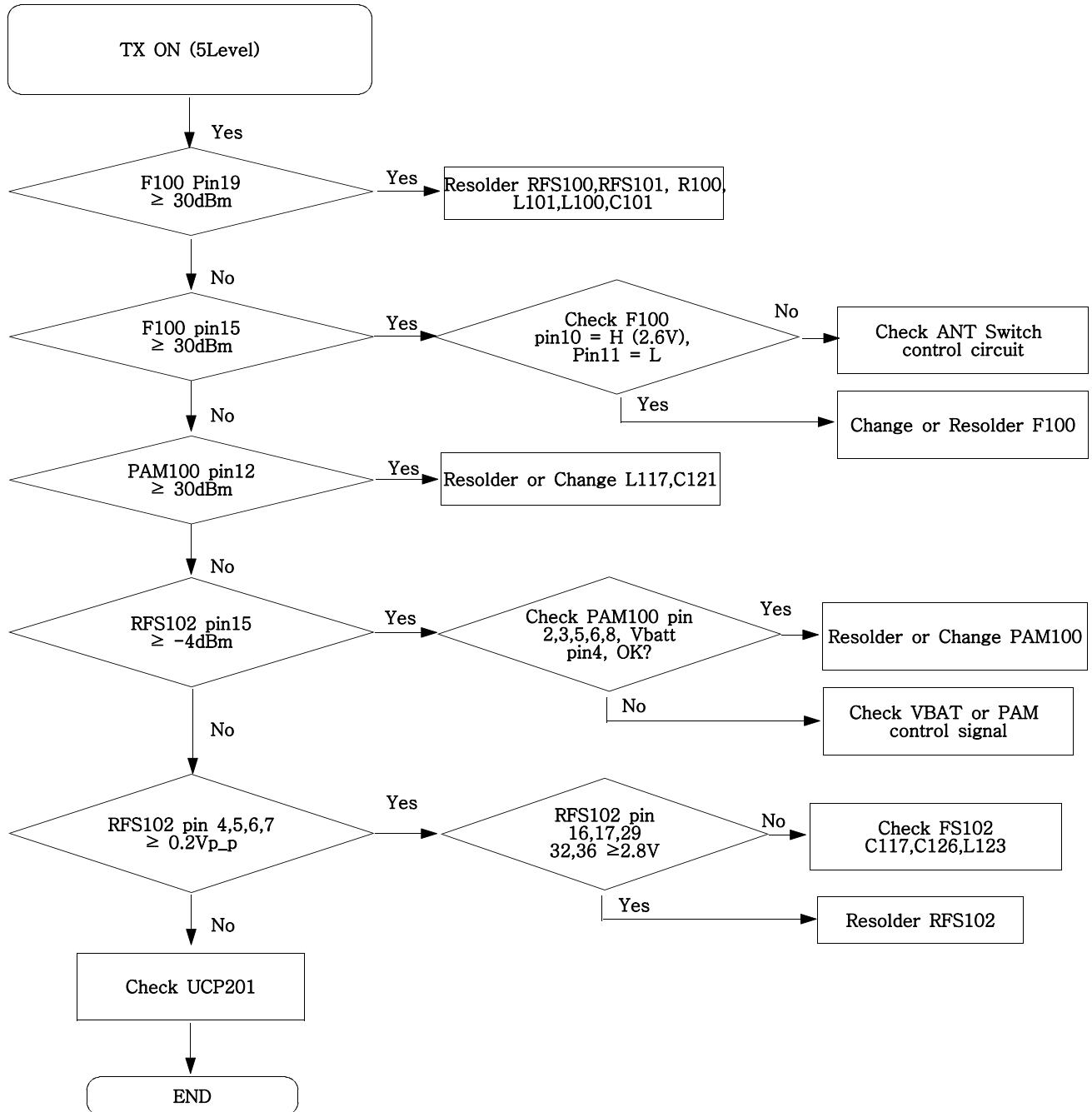

9-16. DCS Receiver

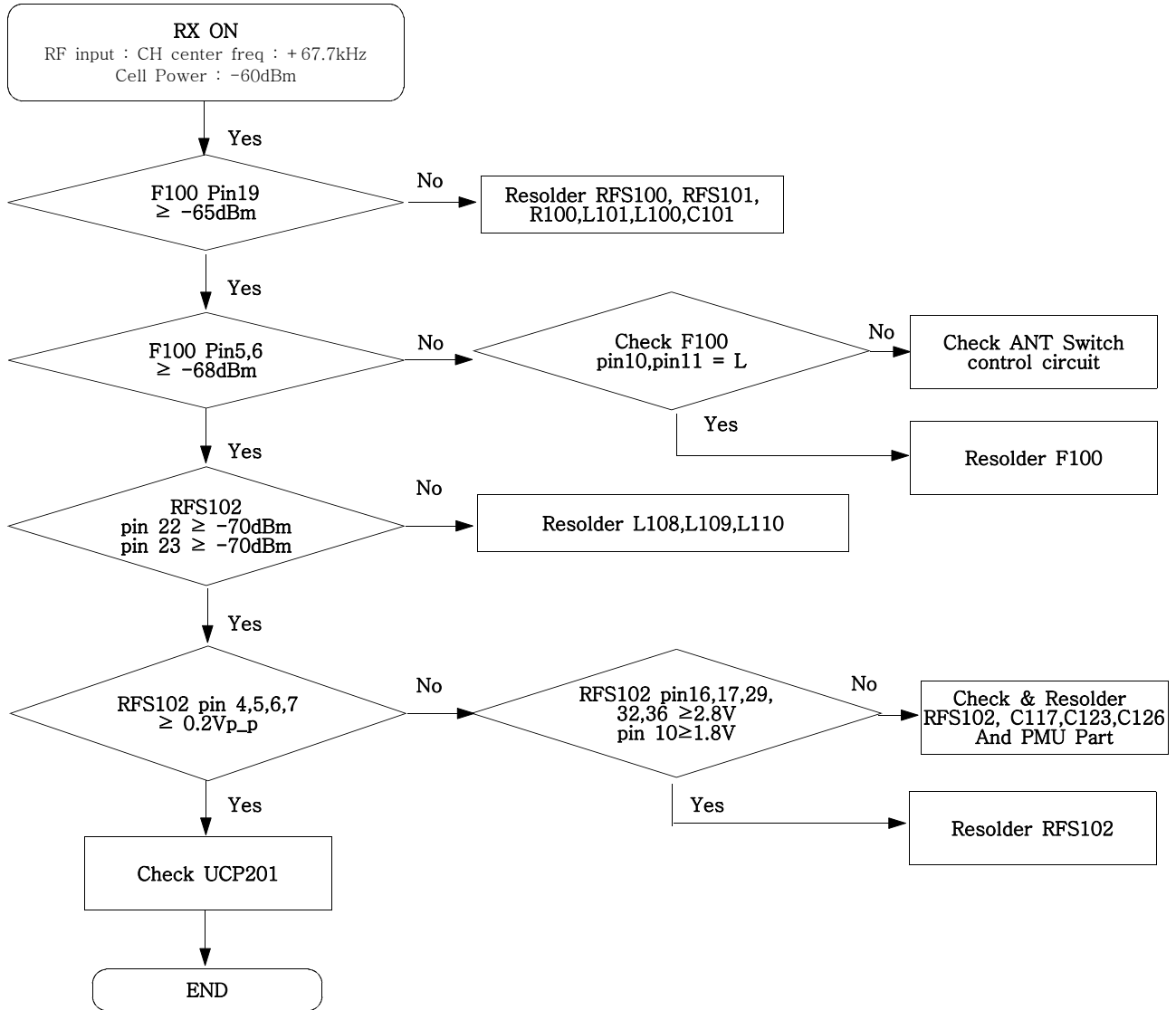

9-17. DCS Transmitter

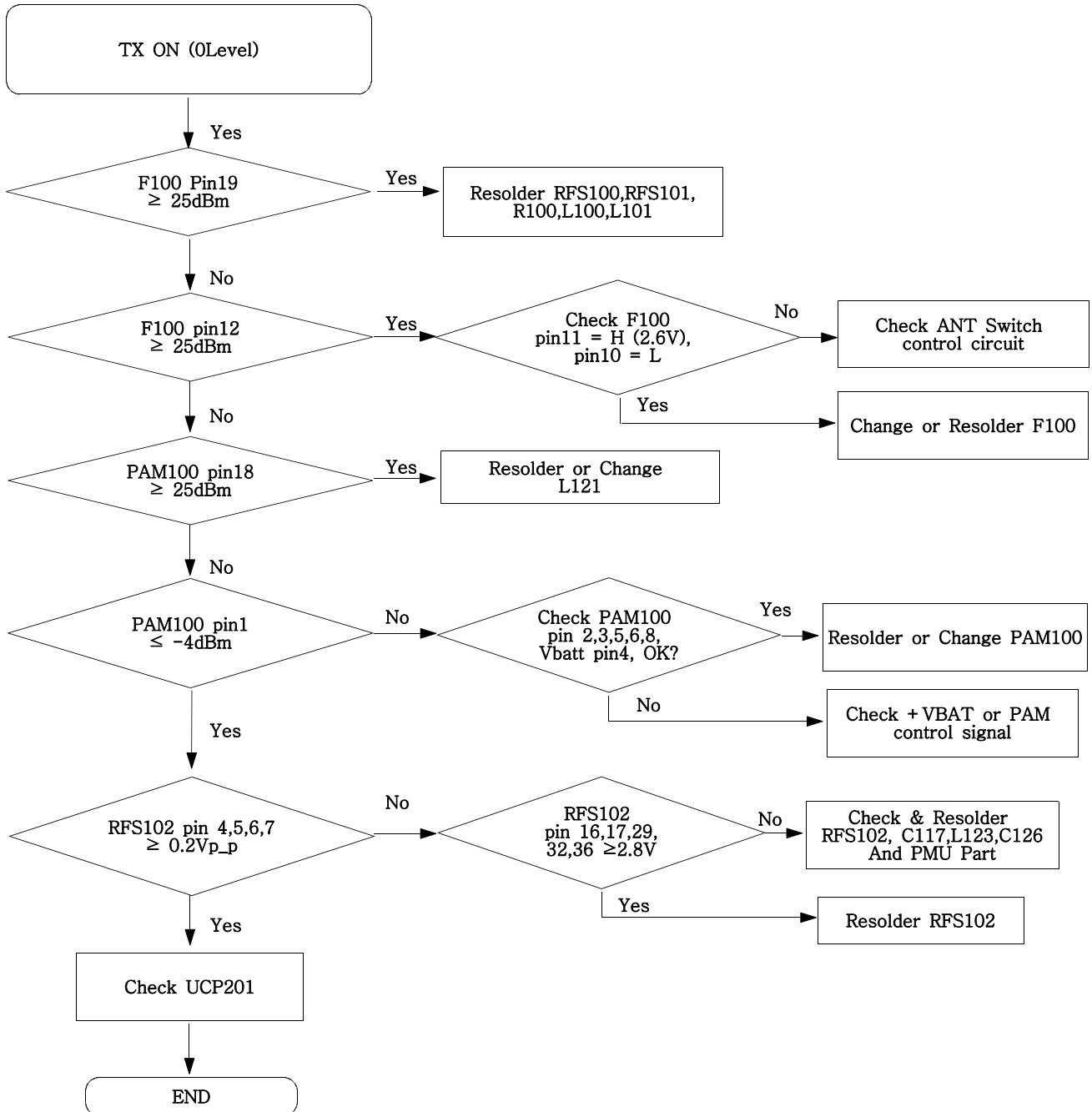

9-18. PCS Receiver

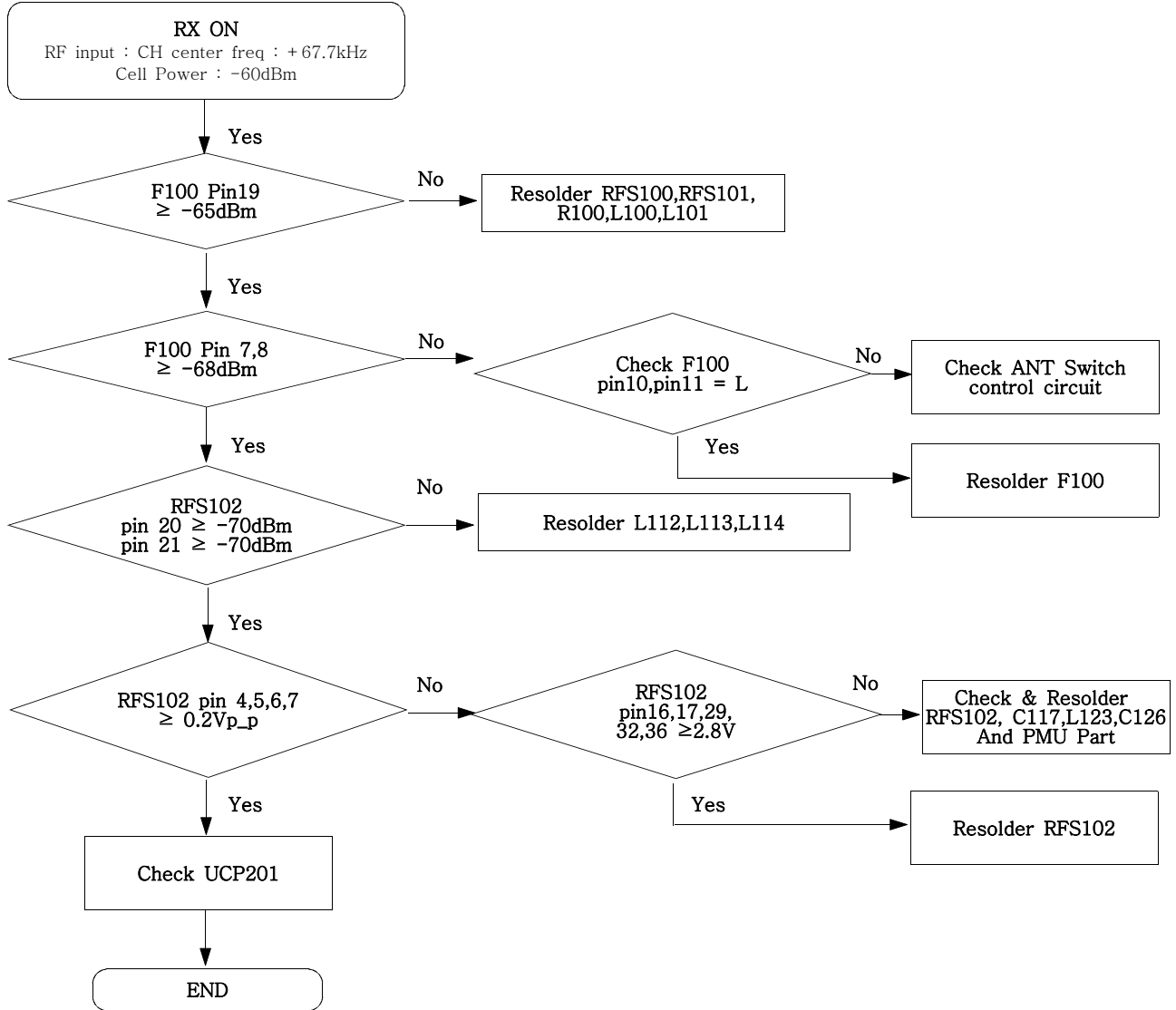

9-19. PCS Transmitter

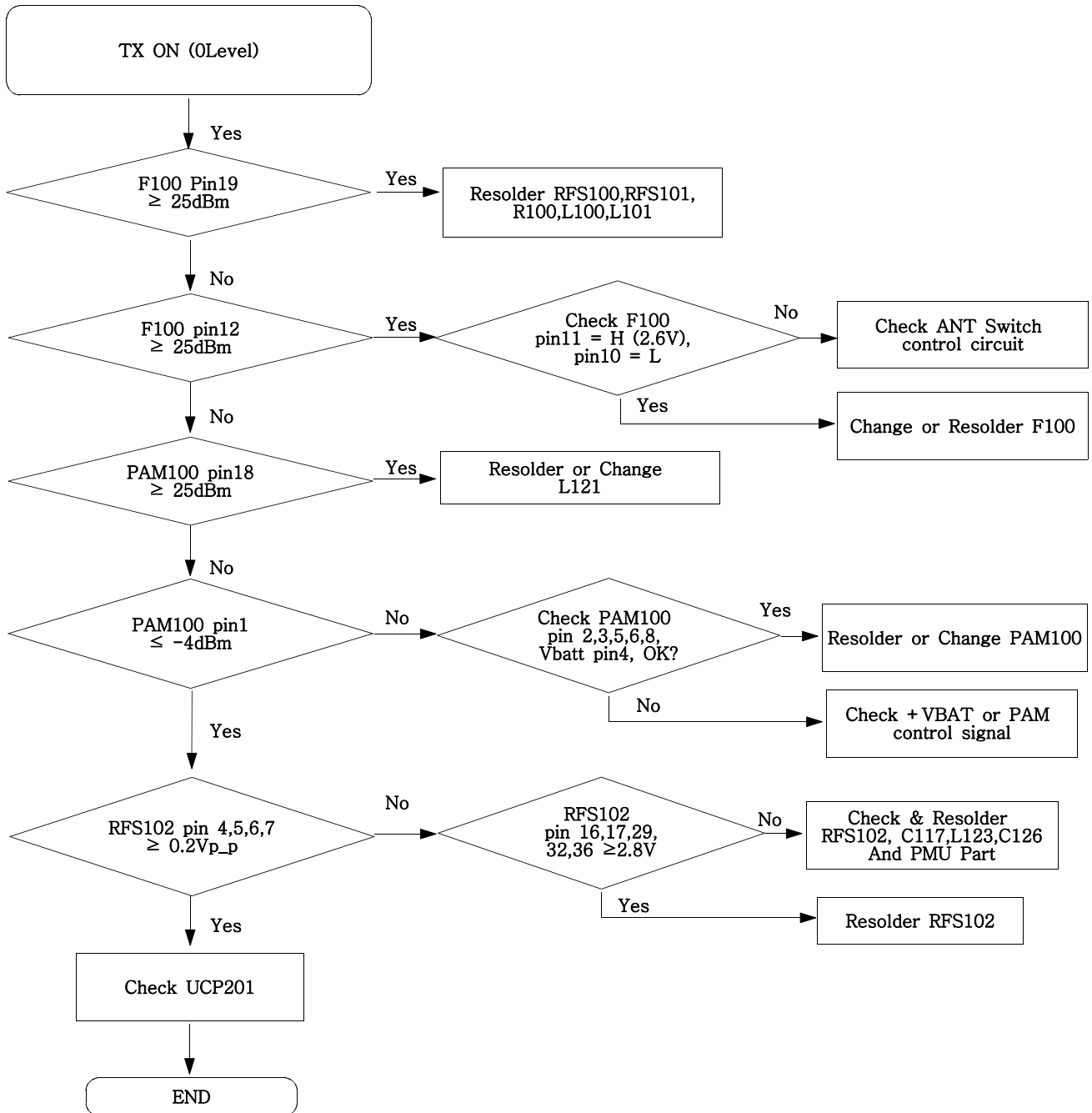

Flow Chart of Troubleshooting

SAMSUNG CONFIDENTIAL
 THIS DOCUMENT CONTAINS CONFIDENTIAL
 SAMSUNG PROPRIETARY INFORMATION.
 IT IS TO BE KEPT STRICTLY CONFIDENTIAL.
 ANY DISCLOSURE TO OR FOR OTHERS FOR
 ANY PURPOSE IS STRICTLY PROHIBITED.

	VC1	VC2
Tx(0x000000)	H	L
Tx(0x100100)	L	H
Rx	L	L

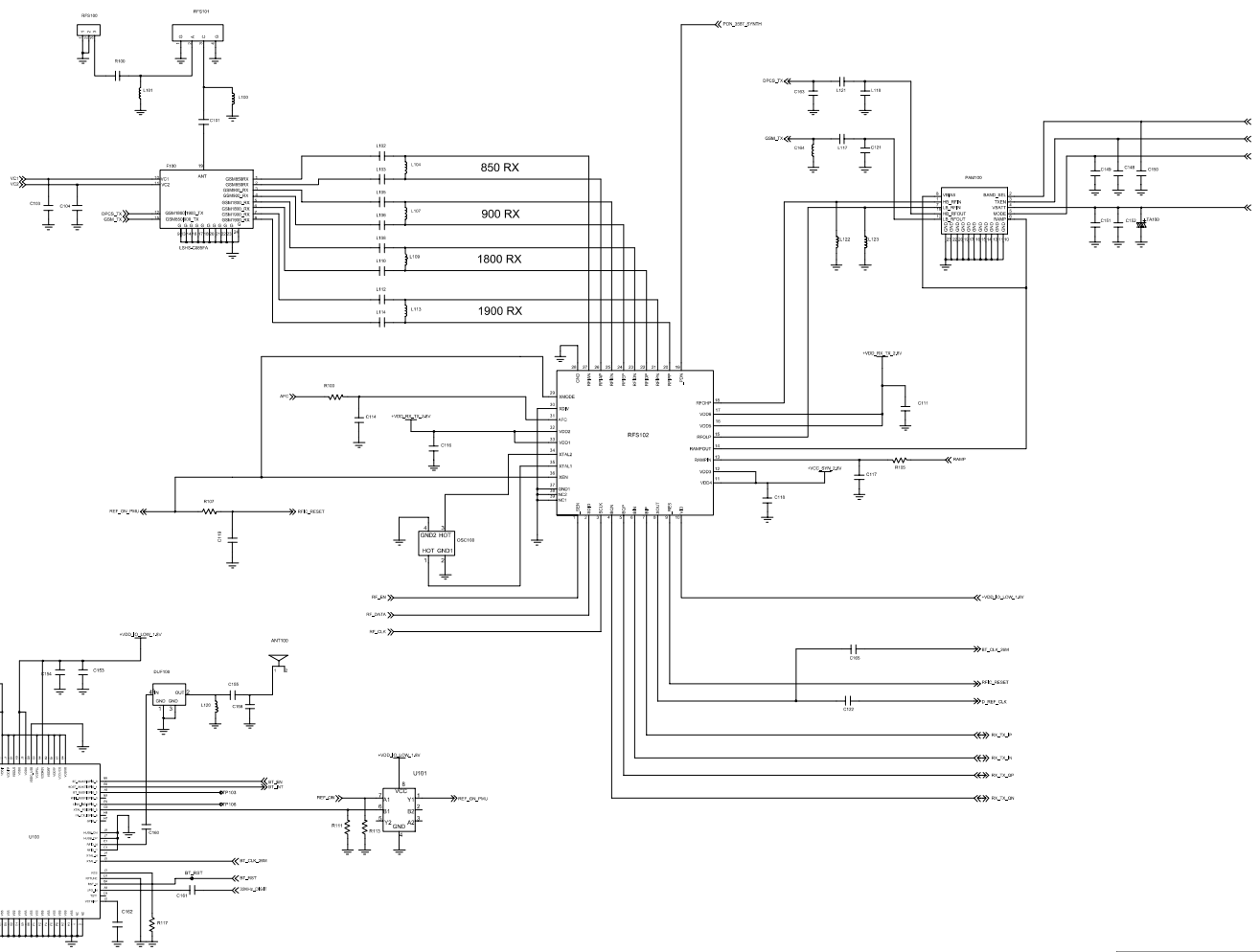

BLUE TOOTH

RF Schematic	
Version Number	SAMSUNGSH4517RF
Date	

9-20. Bluetooth part

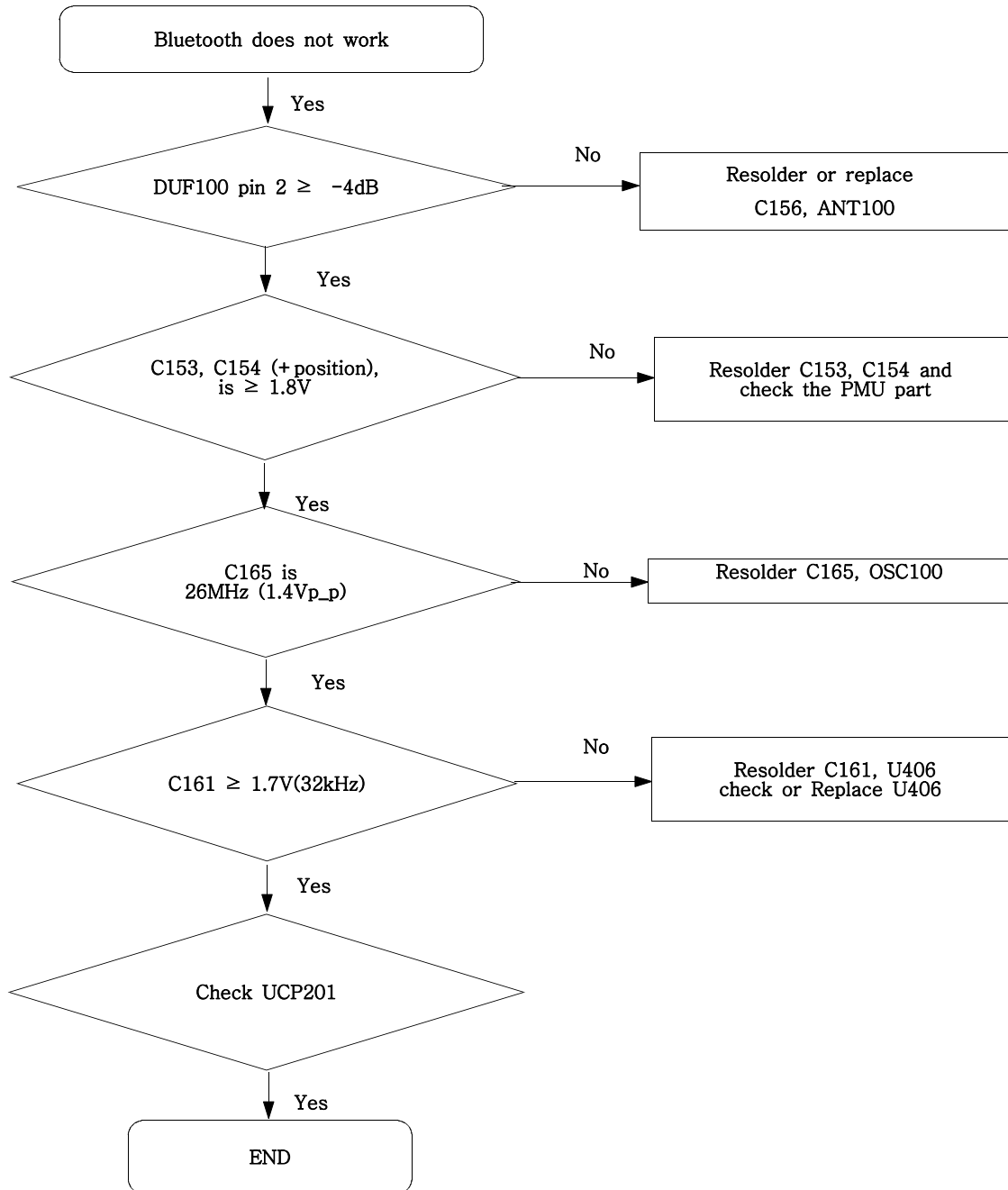

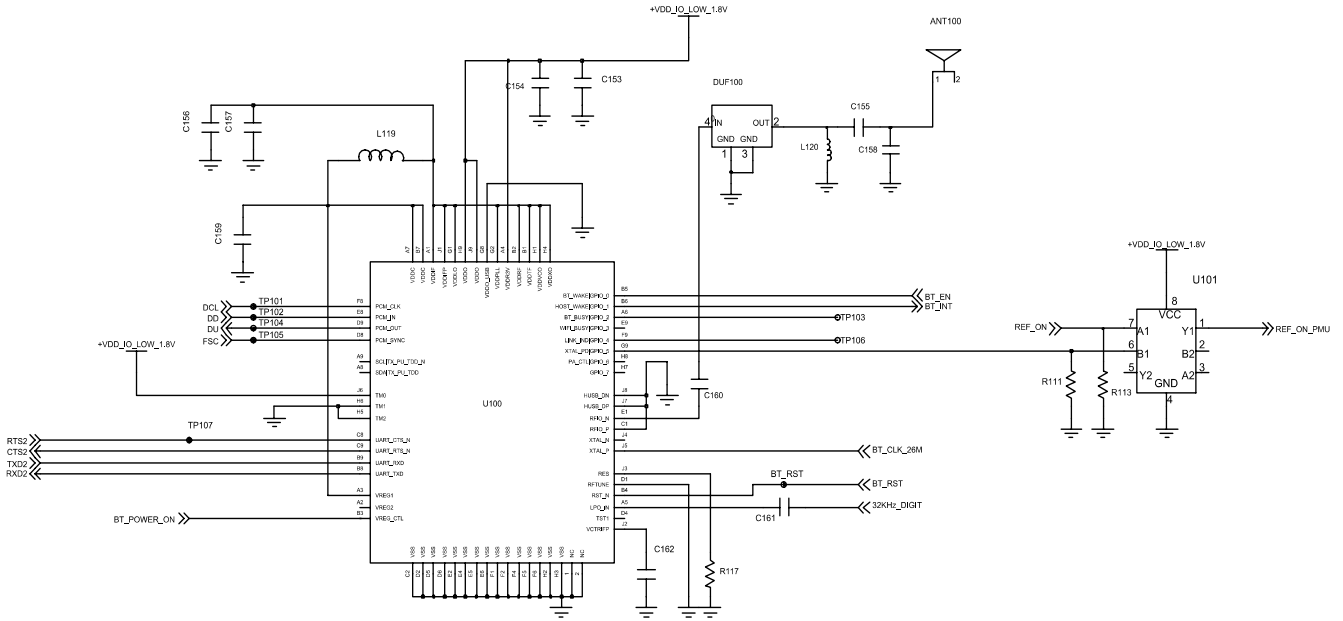

BLUE TOOTH

10. Reference data

Reference Abbreviate

AAC: Advanced Audio Coding.
AVC : Advanced Video Coding.
BER : Bit Error Rate
BPSK: Binary Phase Shift Keying
CA : Conditional Access
CDM : Code Division Multiplexing
C/I : Carrier to Interference
DMB : Digital Multimedia Broadcasting
EN : European Standard
ES : Elementary Stream
ETSI: European Telecommunications Standards Institute
MPEG: Moving Picture Experts Group
PN : Pseudo-random Noise
PS : Pilot Symbol
QPSK: Quadrature Phase Shift Keying
RS : Reed-Solomon
SI : Service Information
TDM : Time Division Multiplexing
TS : Transport Stream

11. Disassembly and Assembly Instructions

11-1. Disassembly

The work guide to disjoint SET – Disjoint REAR



Remove the Rear Screw Deco



Remove the Screws (6 Points)



Open the side with a knife
(from the bottom)



Open the side with a knife
(to the top)

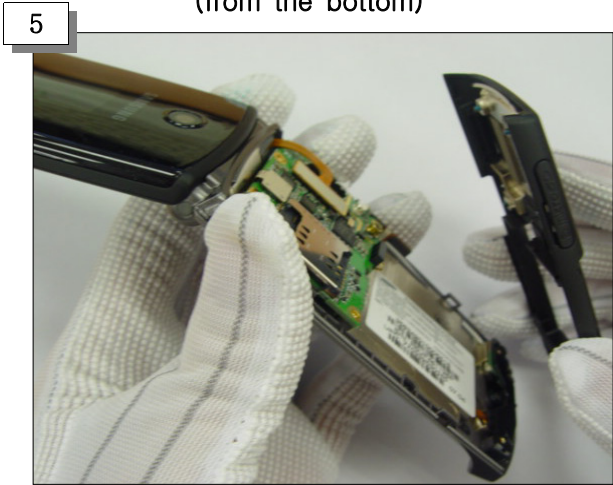

Disjoint the Rear

The work guide to disjoint SET - Disjoint PBA



Disjoint the LCD Connector



Disjoint the KEY Connector

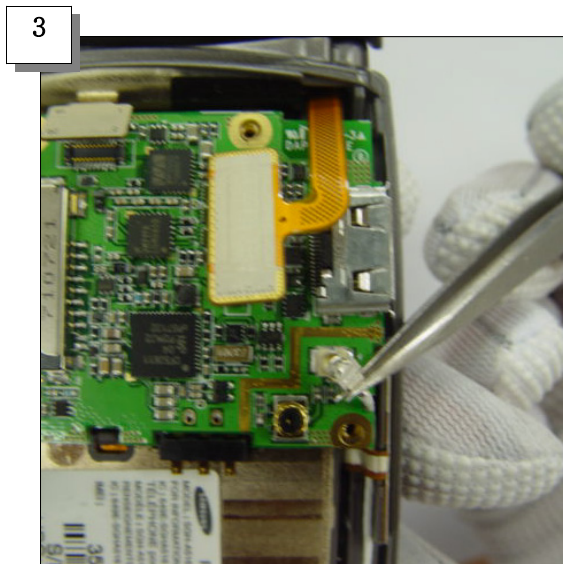

Disjoint the Antenna Switch



Draw the PBA out

The work guide to disjoint SET – Disjoint FRONT

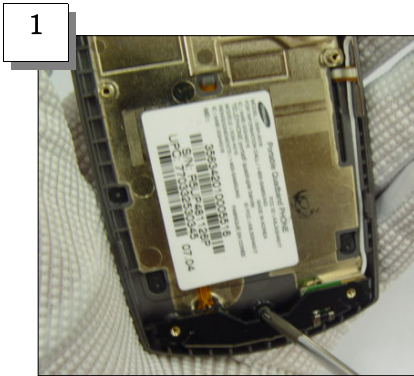

1 Remove the Screw from the Antenna

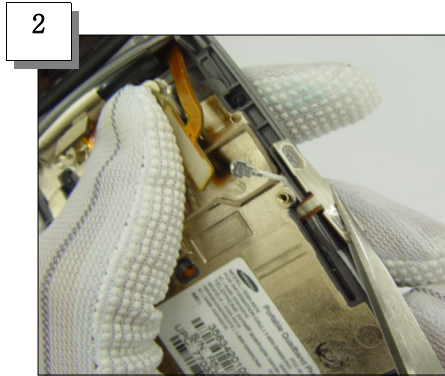

2 Tear the Sidekey Dome off

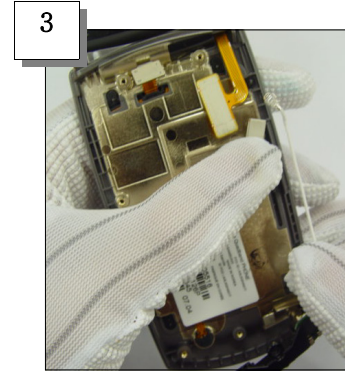

3 Disjoint the Antenna & Wire

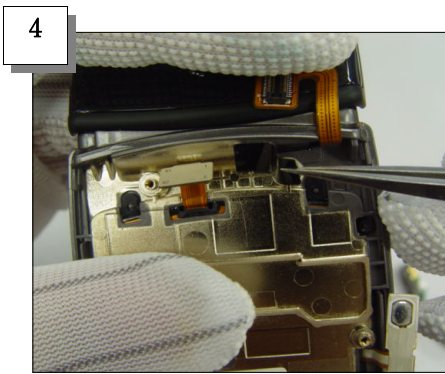

4 Remove the Dustproof Tape

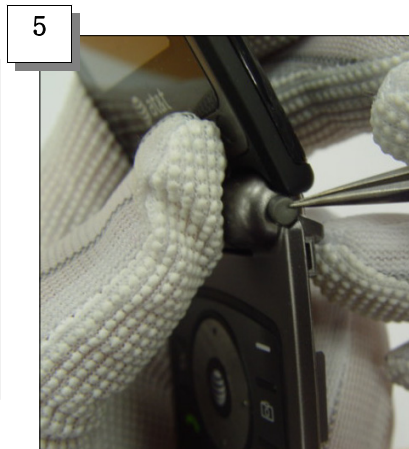

5 Remove the Rubber beside the Front

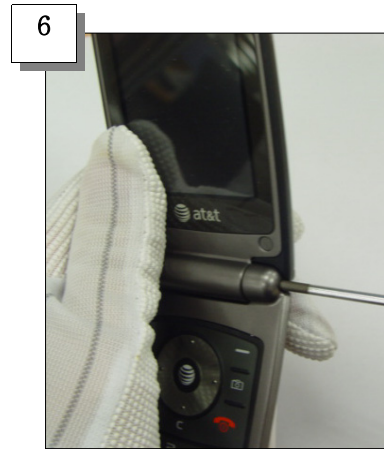

6 Press the Hinge with a lever



7 Disjoint Folder and Front

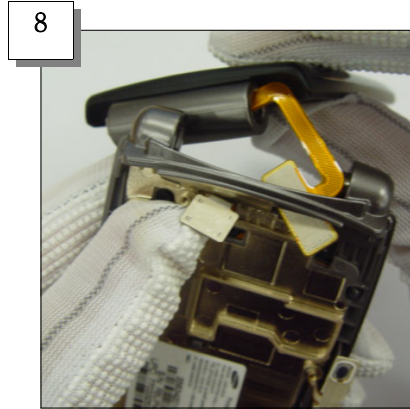

8 Draw out the LCD Connector from Front

The work guide to disjoint SET – Disjoint FOLDER



1 Remove the Screw Caps (2 Points)

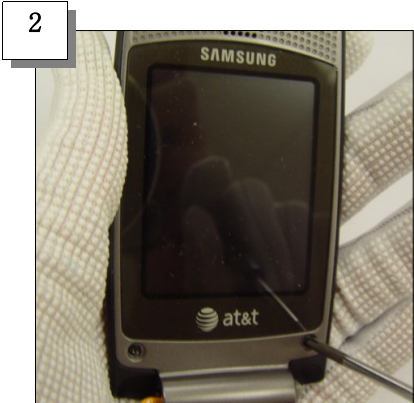

2 Remove the Screws (2 Points)

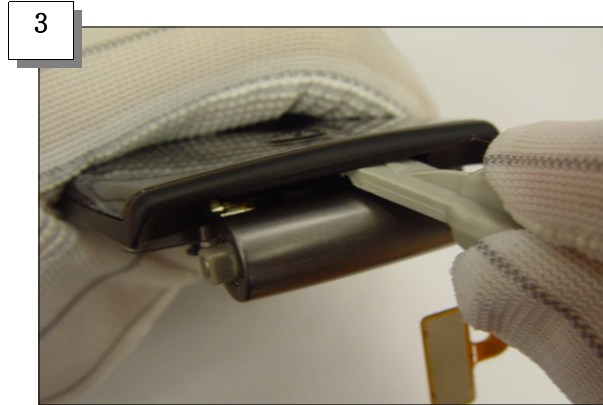

3 Open the Upper's top part with a knife

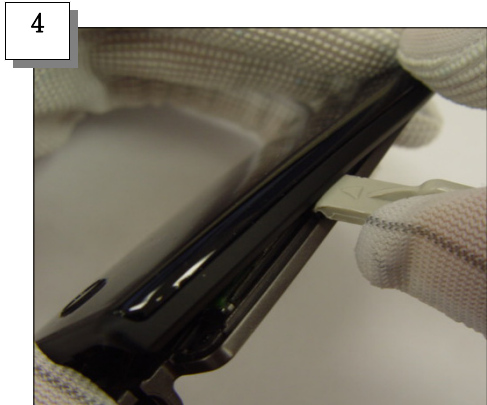

4 Open the side with a knife



5 Oepn the side with a knife
(Opposite Side)



6 Draw the Upper out

The work guide to disjoint SET - Disjoint Touch Key

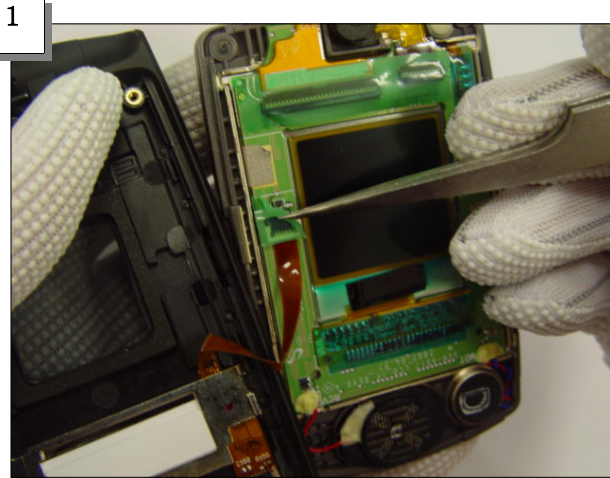

Remove the Tape on the Connector

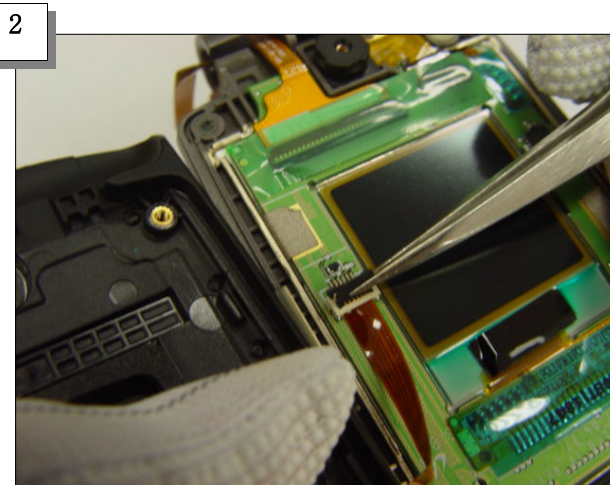

Open the Connector

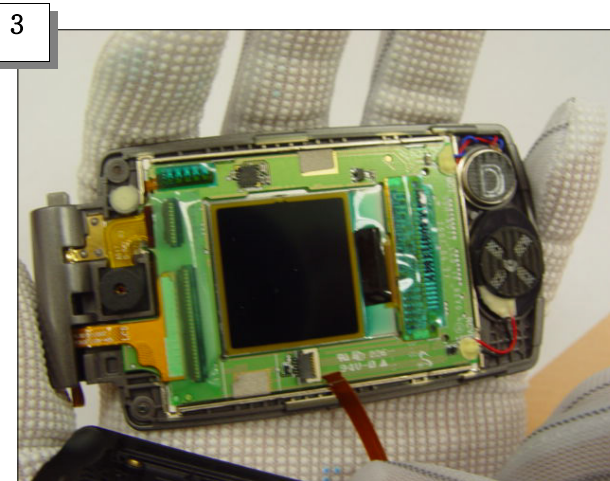

Draw the FPCB out

The work guide to disjoint SET – Disjoint LCD

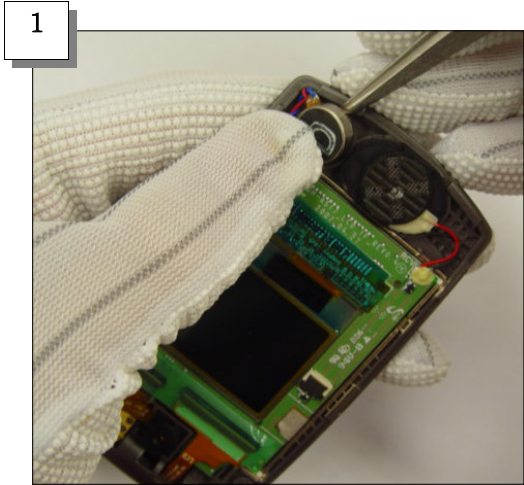

Draw the Motor out

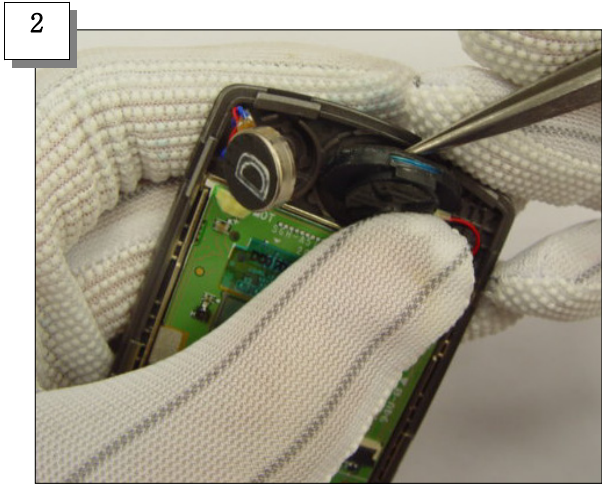

Draw the Speaker out

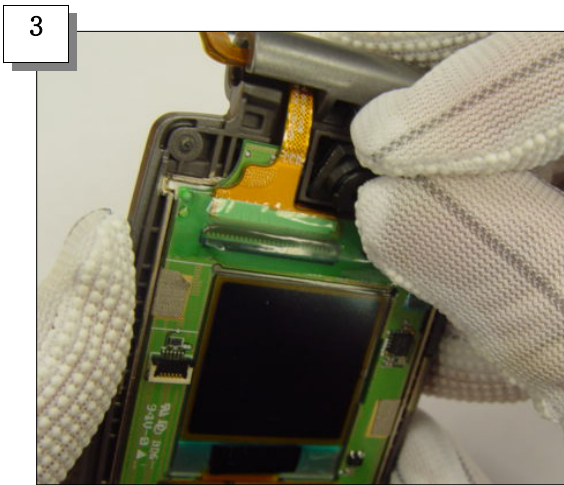

Draw the Camera out

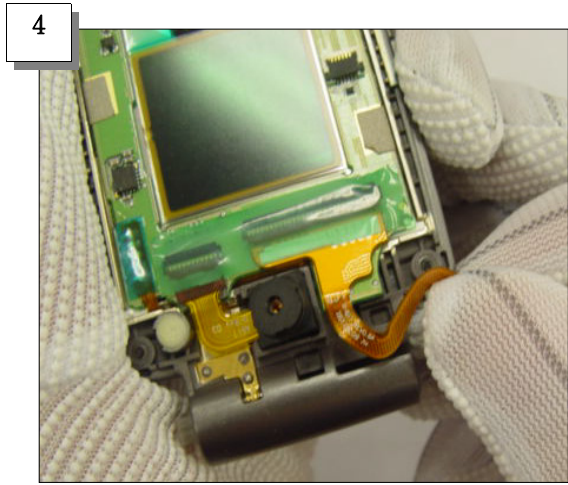

Draw the LCD FPCB out from the Lower hole

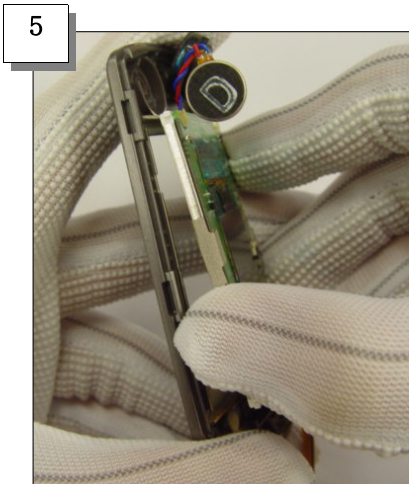

Tear the LCD off

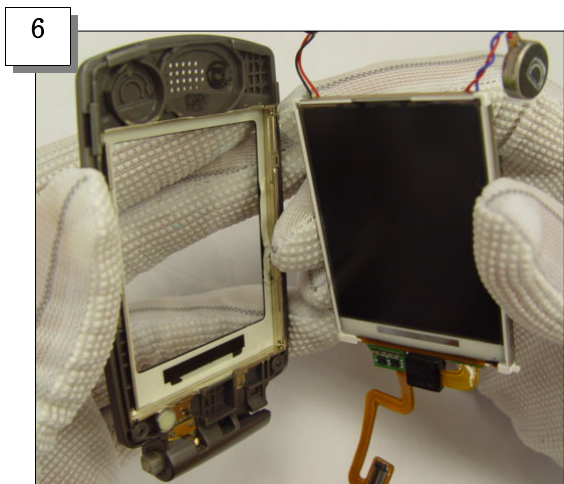

Disjoint the LCD from the Lower

11-2. Assembly

The work guide to assemble SET - LOWER

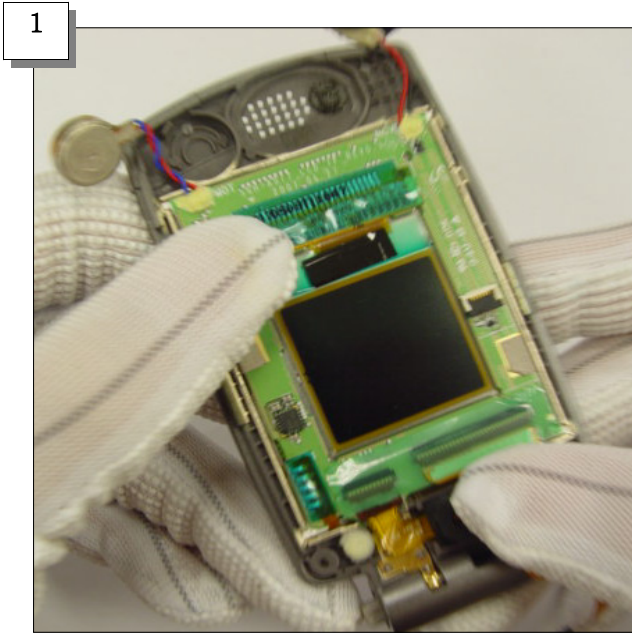

Join the LCD & Camera to the Lower

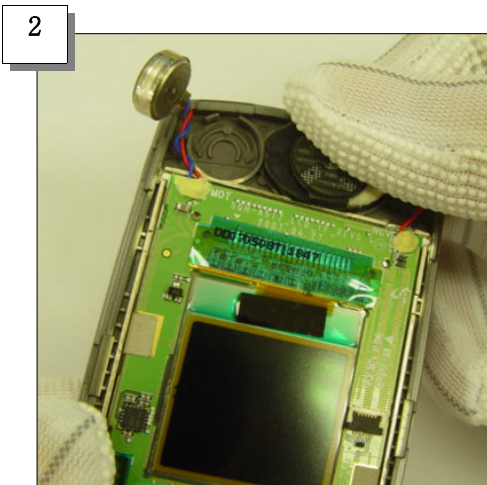

Join the Speaker to the Lower

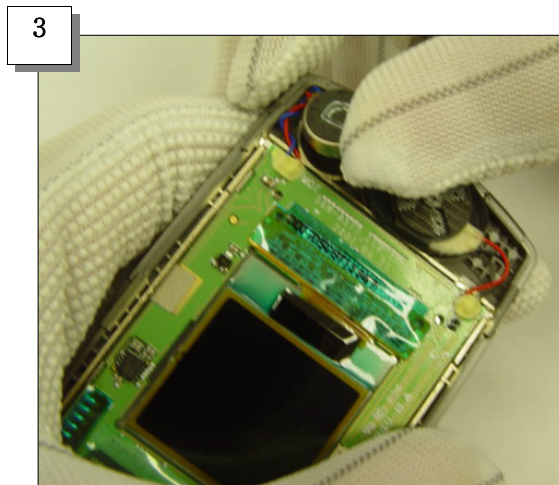

Join the Motor to the Lower

The work guide to assemble SET - FRONT & LOWER

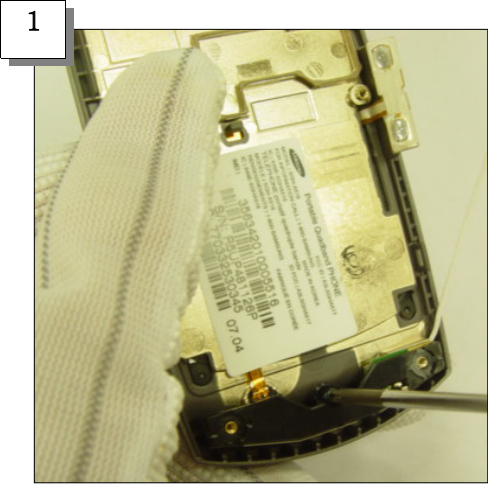

Join the Screw to the Antenna

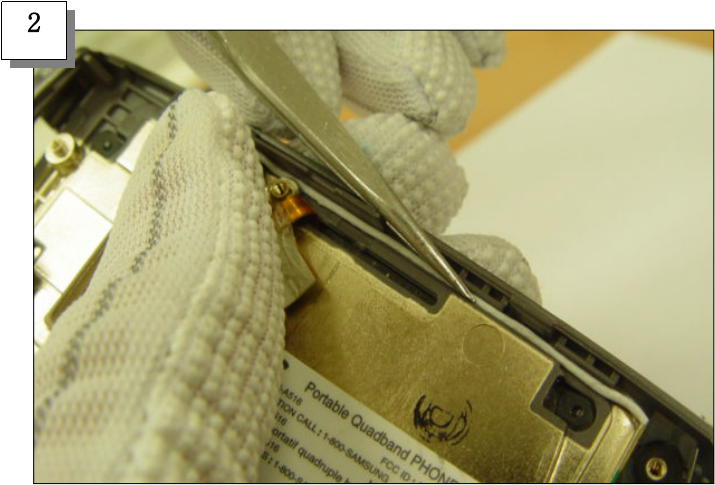

Arrange the Antenna wire in the guide hole

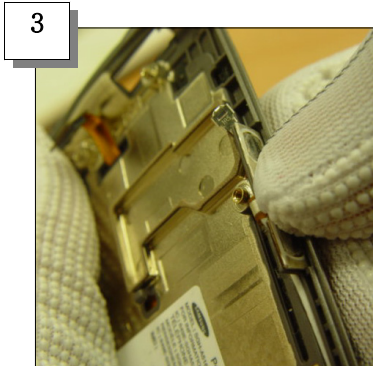

Join the Sidekey

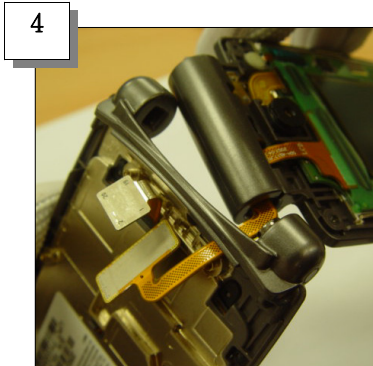

Put LCD FPCB in the Front Hinge

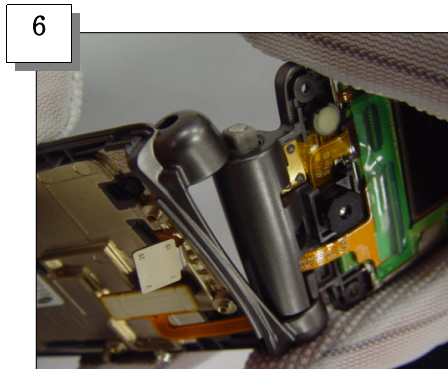
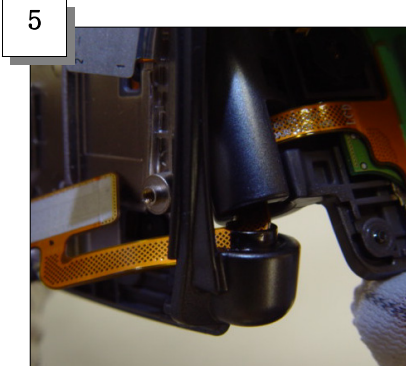

Join the Lower to the Front by using the lever like the picture 6, 7 and 8

The work guide to assemble SET - UPPER

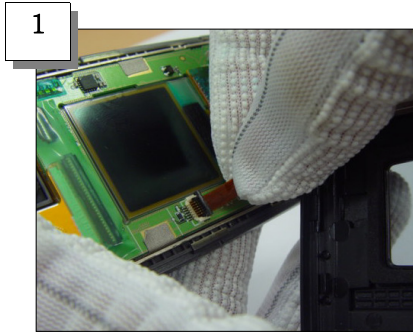

1
Join the Touch key to the connector

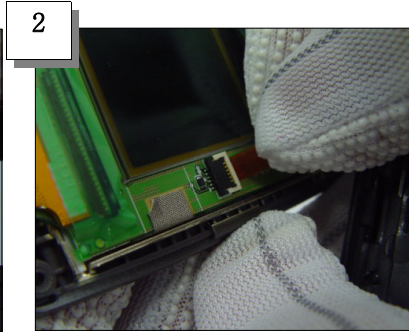

2
Close the Connector

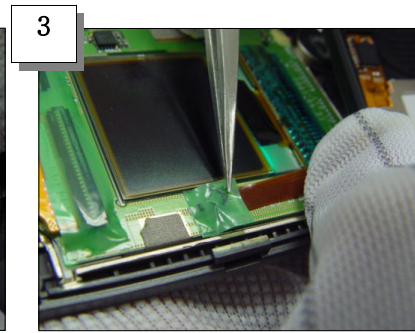

3
Attach the Tape on the Connector



4
Join the Upper to the bottom of the Lower

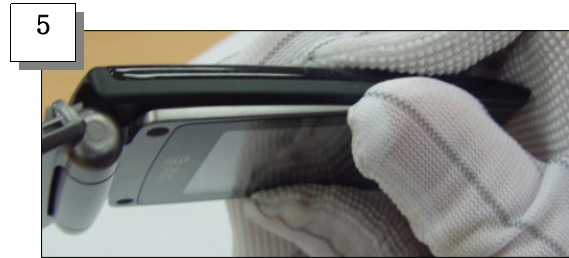

5
Assemble the middle of the Upper

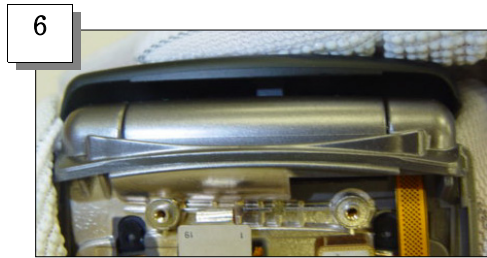

6
Join the Upper to the top of the Lower



7
Assemble the top of the Upper



8
Tighten the Screws (2 Points)



9
Attach the Screw caps (2 Points)

The work guide to assemble SET - PBA

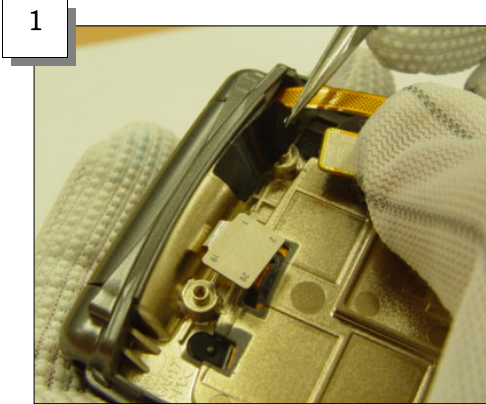

Attach the Dustproof Tape

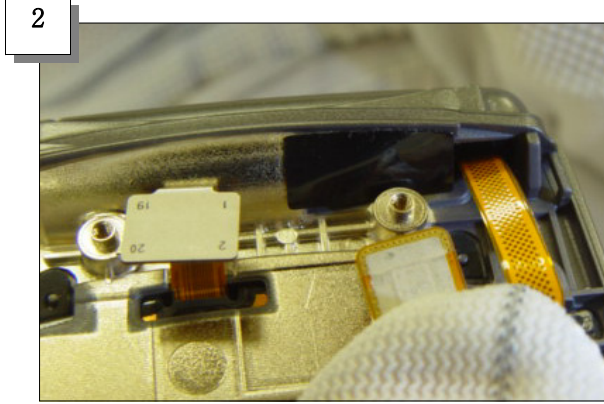

Check if working is correct



Join the PBA to the Front
(Put the Antenna wire
in the hole in the PBA)

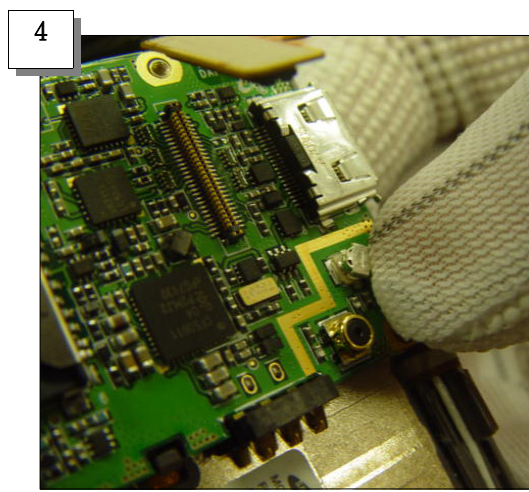

Join the Antenna switch
to the PBA

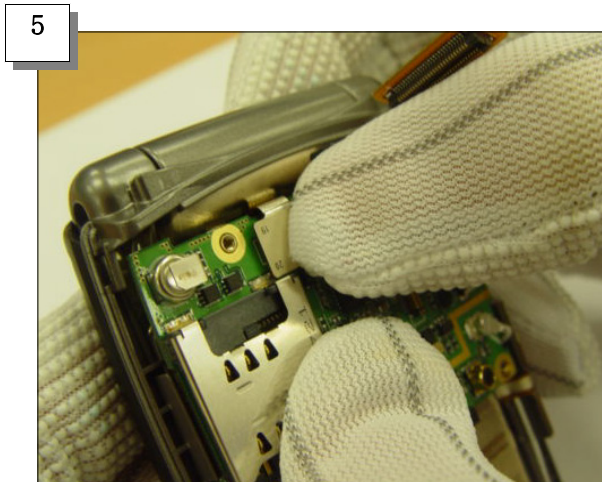

Assemble the Key Connector



Assemble the LCD Connector

The work guide to assemble SET - REAR



Join the Rear to the Front
(Top 2 Points)



Join the Sidekey
between Front and Rear



Join the Rear to the Front
(Middle 2 Points)

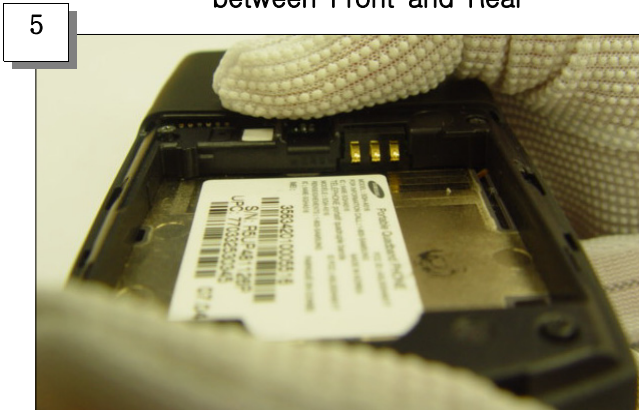

Join the Center part
so that hooker is locked correctly



Tighten the Screws (6 Points)



Attach the Rear Screw Deco

